

Appendix 14A: Proposed Pricing Methodology (1 April 2022 – 31 March 2027)

2023-27 Transmission Revenue Reset

PUBLIC

Submitted: 29 October 2020

Table of Contents

1	Introduction	4
2	Rules requirements.....	5
3	AusNet Services' aggregate annual revenue requirement	6
4	Allocation of AARR to categories of prescribed transmission services	7
4.1	Overview of allocation principles.....	7
4.2	Application of the allocation principles	8
4.2.1	Lines.....	8
4.2.2	Transformers.....	8
4.2.3	Switchgear	8
4.2.4	Busbars and rack structures	8
4.2.5	Reactive compensation plant.....	9
4.2.6	Land and station establishment	9
4.2.7	Communications	9
4.2.8	Secondary systems.....	9
4.2.9	Transmission operations centre.....	9
4.2.10	System spares	9
4.2.11	Non-system assets	9
4.2.12	Easements	9
4.2.13	Easements land tax	9
4.3	Example of the application of the allocation principles	9
5	Allocation of the ASRR to transmission network connection points.....	11
5.1	Overview of allocation principles.....	11
5.2	Application of the allocation principles	11
5.2.1	Shared entry services	12
5.2.2	Shared exit services.....	12
5.2.3	Shared exit and entry services.....	13
5.3	Recovery of the ASRR as prices	13
6	Information requirements and billing	14
6.1	Compliance with Rule 6A.27	14
7	Prudential requirements.....	15
7.1	Prudential requirements for prescribed transmission services	15

7.2	Capital contribution or prepayment for a specific asset	15
Appendix A – Structure of transmission pricing in Victoria		16
Appendix B – Priority ordering methodology		17
B.1	Rules requirements	17
B.2	Objective and general approach	18
B.3	Proposed methodology	18
B.4	Definition - Branches	19
B.5	Examples	20
B.5.1	Example A	20
B.5.2	Example B	22
B.5.3	Example C	24
B.5.4	Example D	26

1 Introduction

Clause 6A.10.1(a) of the National Electricity Rules (*Rules*) requires a Transmission Network Service Provider (*TNSP*) to submit a proposed *pricing methodology* to the Australian Energy Regulator (*AER*) at the same time that the provider submits its *Revenue Proposal* relating to its *prescribed transmission services*.

AusNet Services is a *TNSP* in Victoria for the purposes of the *Rules*. This document sets out AusNet Services' proposed *pricing methodology* for the period 1 April 2022 to 31 March 2027 and has been prepared in accordance with AusNet Services' obligations under the *Rules*. This pricing methodology is identical to that approved for the current regulatory control period.

It is important to note that the transmission arrangements in Victoria differ from those in other states, given the roles and responsibilities that are ascribed to AusNet Services and the *Australian Energy Market Operator (AEMO)*. In relation to pricing matters, AusNet Services allocates its *aggregate annual revenue requirement (AARR)* to each of the *categories of prescribed transmission services*, and is also responsible for pricing *connection services*. *AEMO* is responsible for pricing *prescribed Transmission Use of System (TUOS) services* and *prescribed common transmission services*. For the purposes of clause 6A.29.1, *AEMO* is the *Co-ordinating Network Service Provider* for Victoria and allocates all relevant *AARR* within Victoria. The diagram in Appendix A shows the delineation of responsibilities between AusNet Services and *AEMO* in relation to transmission pricing under Part J of Chapter 6A of the *Rules*.

In light of the arrangements in Victoria, this proposed *pricing methodology* only addresses the pricing matters for which AusNet Services has responsibility. *AEMO* is subject to specific pricing methodology provisions set out in Schedule 6A.4.2 (f) of the *Rules*. At the time of submission of this document, *AEMO* has an approved Undertaking in place to apply its most recent *AER* approved pricing methodology until 30th June 2021.

AusNet Services will monitor compliance with its pricing methodology, the relevant pricing principles and Part J of the *NER* through the established audit process conducted as part of the annual pricing process undertaken to enable *AEMO* to issue transmission prices.

The remaining sections of this document are structured as follows:

- Section 2 – sets out the key requirements for pricing methodologies in the *Rules*.
- Section 3 – defines the *AARR* in accordance with the *Rules*.
- Section 4 – explains the allocation of the *AARR* to the *categories of prescribed transmission services* in accordance with clauses 6A.23.2 and 11.6.11, in order to establish the *annual service revenue requirements (ASRR)* for each category.
- Section 5 – explains the allocation of the *ASRR* to *transmission network connection points* in accordance with clause 6A.23.3.
- Section 6 – explains the application of the principles for the recovery of the *ASRR* as prices to the charges for *connection services* in accordance with clause 6A.23.4.
- Section 7 – describes the requirements relating to information provision, and the billing arrangements in accordance with clause 6A.27.
- Section 8 – sets out AusNet Services' prudential requirements as required by rule 6A.28.

Throughout this document, terms which appear in *italics* have the meaning given to them in the *Rules*.

2 Rules requirements

Clause 6A.24.1(b) of the *Rules* states that the pricing methodology applied by a *TNSP*:

1. Allocates the aggregate annual revenue requirement (AARR) for prescribed transmission services provided by the *TNSP* to each category of prescribed transmission services;
2. Provides for the manner and sequence of adjustments to the annual service revenue requirement (ASRR);
3. Allocates the ASRR to transmission network connection points (other than *connection points* of any *Market Network Service Provider*); and
4. Determines the structure of the prices that a *TNSP* may charge for each category of prescribed transmission services under 6A.23.4(a)¹.

The pricing methodology must comply with the principles and guidelines established by or made under the *Rules*. Clause 6A.10.1(e) of the *Rules* requires that the proposed pricing methodology must:

- (1) give effect to and be consistent with the *Pricing Principles for Prescribed Transmission Services*, which are set out in rule 6A.23; and
- (2) comply with the requirements of, and contain or be accompanied by such information as is required by, the *pricing methodology guidelines* made for that purpose under rule 6A.25.

Further, under clause 6A.24.1(d), a *TNSP* must comply with the *pricing methodology* approved by the *AER* as part of a *transmission determination* that applies to that *TNSP*, and any other applicable requirements in the *Rules*, when the *TNSP* is setting the prices that may be charged for the provision of *prescribed transmission services*.

¹ Under the current Victorian transmission arrangement, AEMO is responsible for setting prices under clause 6A.23.4(a)(1), (2) and (3) of the *Rules*.

3 AusNet Services' aggregate annual revenue requirement

As required by the *Rules*, AusNet Services determines the *AARR* in accordance with rule 6A.3 and clause 6A.22.1. Clause 6A.22.1 states that for the purposes of pricing regulation, the *AARR* for *prescribed transmission services* provided by a *TNSP* is the *maximum allowed revenue* referred to in clause 6A.3.1 adjusted:

- (1) in accordance with clause 6A.3.2, and
- (2) by subtracting the operating and maintenance costs expected to be incurred in the provision of prescribed common transmission services.

Clause 6A.3.1 states that the revenue that a *TNSP* may earn in any regulatory year of a regulatory control period from the provision of *prescribed transmission services* is the maximum allowed revenue subject to any adjustments referred to in clause 6A.3.2, and is to be determined in accordance with:

- (a) the revenue determination forming part of the applicable transmission determination; and
- (b) the provisions of Part C of Chapter 6A, which relate to the regulation of revenue for *prescribed transmission services*.

The operating and maintenance costs that are subtracted from the maximum allowed revenue are determined by reference to the revenue determination operating and maintenance costs forecasts. The costs allocated to common services are those that cannot or should not be allocated to specific assets or by asset share and consist of:

- System operation opex;
- Non-System opex;
- Land taxes / rates;
- Insurance and self-insurance;
- Debt and equity raising Costs; and
- Easement land tax costs.

The effect of clause 6A.3.1 is that the *AARR* is to be determined by reference to AusNet Services' *revenue determination*. AusNet Services undertakes to ensure that the *AARR* for price setting purposes is determined in accordance with its *revenue determination* relating to the 2023 - 2027 *regulatory control period* and is depicted in Appendix A of this pricing methodology.

4 Allocation of AARR to categories of prescribed transmission services

4.1 Overview of allocation principles

Clauses 6A.22.3, 6A.23.2 and 11.6.11 of the *Rules* provide the framework for calculating AusNet Services' *annual service revenue requirement (ASRR)*.

Clause 6A.23.2 of the *Rules* requires the *AARR* to be allocated in accordance with the following principles:

- (a) The *AARR* for a *TNSP* must be allocated to each *category of prescribed transmission services* in accordance with the *attributable cost share* for each such category of services.
- (b) This allocation results in the *annual service revenue requirement (ASRR)* for that category of services.
- (c) The allocation of the *AARR* must be such that:
 - (1) every portion of the *AARR* is allocated; and
 - (2) the same portion of the *AARR* is not allocated more than once.
- (d) Where, as a result of the application of the *attributable cost share*, a portion of the *AARR* would be attributable to more than one *category of prescribed transmission services*, that *attributable cost share* is to be adjusted and applied such that any costs of a *transmission system asset* that would otherwise be attributed to the provision of more than one *category of prescribed transmission services*, is allocated as follows:
 - (1) to the provision of *prescribed TUOS services*, but only to the extent of the *stand-alone amount* for that category of *prescribed transmission services*;
 - (2) if any portion of the costs of a *transmission system asset* is not allocated to *prescribed TUOS services* under subparagraph (1), that portion is to be allocated to *prescribed common transmission services*, but only to the extent of the *stand-alone amount* for that category of *prescribed transmission services*;
 - (3) if any portion of the costs of a *transmission system asset* is not attributed to *prescribed transmission services* under subparagraphs (1) and (2), that portion is to be attributed to *prescribed entry services* and *prescribed exit services*.

Clause 6A.22.3 defines *attributable cost share* as follows:

- (a) For a *TNSP* for a *category of prescribed transmission services*, the *attributable cost share* for that *TNSP* for that category of services must, subject to any adjustment required or approved, under this Part, substantially reflect the ratio of:
 - (1) the costs of the *transmission system assets* directly attributable to the provision of that *category of prescribed transmission services*; to
 - (2) the total costs of all the *TNSP's transmission system assets* and any other *transmission system assets* directly attributable to the provision of *prescribed transmission services*.
- (b) The costs of the *transmission system assets* referred to in paragraph (a) refers to optimised replacement cost or to an accepted equivalent to optimised replacement cost that is referable to values contained in the accounts of the *TNSP*.

4.2 Application of the allocation principles

In accordance with clause 6A.22.3(a), AusNet Services determines the *attributable cost share* for each category of *prescribed transmission services* by calculating the ratio of:

- (1) the costs of the *transmission system assets* directly attributable to the provision of that *category of prescribed transmission services*; to
- (2) the total costs of AusNet Services' *transmission system assets* and any other *transmission system assets* directly attributable to the provision of *prescribed transmission services*.

In accordance with clause 6A.22.3(b), AusNet Services values its assets in accordance with an optimised replacement cost (ORC) methodology.

To give effect to the allocation process, the costs of *transmission system assets* must be allocated to a *category of prescribed transmission services* in accordance with clause 6A.23.2 of the *Rules*. The *categories of prescribed transmission services* to which the costs can be allocated are set out in clause 6A.23.2(d). This clause must be read together with clause 11.6.11. Clause 11.6.11 is a transitional provision which deems certain *connection services* provided to *Generators* and customers directly connected to the *transmission network* for *connections* in place or committed to be in place as at 9 February 2006 to be a *prescribed connection service*. A full description of the priority ordering methodology is provided in Appendix B to this *pricing methodology*.

The following paragraphs identify the *category or categories of prescribed transmission service* to which each of AusNet Services' asset categories (and its ORC) is allocated.

4.2.1 Lines

All lines are allocated to *prescribed TUOS services*, with the following exceptions:

- 66 kV double circuit lines between Cranbourne and Frankston Terminal Stations; and
- 66 kV double circuit lines between Templestowe Terminal Station and DNSP zone substations DC, HB, L and WD.

The line assets listed immediately above are allocated to *prescribed exit services*, as each of the above lines is radial and connects a particular user to the *transmission network*.

4.2.2 Transformers

The main system tie transformers are allocated to *prescribed TUOS services*. Connection Transformers are allocated to *prescribed entry services*.

4.2.3 Switchgear

A shallow connection policy is applied in determining the allocation of switchgear. In accordance with this policy, switchgear is assigned to *prescribed entry services* and *prescribed exit services* only when those assets provide *supply* to *Network Users* connected at the *connection point*. The remainder are assigned to *prescribed TUOS services*.

4.2.4 Busbars and rack structures

Busbars and rack structures are not separately identified for allocation. Instead, they are included in the relevant switchgear, transformer or reactive primary bays and the establishment costs at each terminal station.

4.2.5 Reactive compensation plant

All reactive plant is assigned to *prescribed common transmission services* as it provides equivalent benefit to all *Transmission Network Users* with the following exceptions:

- *Reactive plant* will be assigned to *prescribed TUOS services* if the benefits of the *reactive plant* can be allocated on a locational basis and agreed with AEMO, but cannot be allocated to a particular user or group of users.
- *Reactive plant* at the sub-transmission *voltage* level will be assigned to *prescribed exit services* if it is clearly evident that the plant has been provided to meet the local reactive requirements of one or more users connected at the relevant terminal station as stipulated in a connection agreement.

4.2.6 Land and station establishment

Land and establishment costs are apportioned between *prescribed exit services* and *prescribed TUOS services* on a case-by-case basis in accordance with the principles set out in clauses 6A.23.2 and 11.6.11.

4.2.7 Communications

All communication assets are assigned to *prescribed common transmission services*.

4.2.8 Secondary systems

Secondary equipment is generally allocated in accordance with the allocation of the associated primary equipment.

4.2.9 Transmission operations centre

All operational costs are assigned to *prescribed common transmission services*.

4.2.10 System spares

System spares are allocated to *prescribed common transmission services*.

4.2.11 Non-system assets

Non-system assets are allocated to *prescribed common transmission services*.

4.2.12 Easements

Easements are allocated to *prescribed common transmission services*.

4.2.13 Easements land tax

As any land tax imposed on transmission easements in Victoria under the Land Tax Act 2005 is directly associated with the value of the easement portfolio, AusNet Services allocates this cost to *prescribed common transmission services*.

4.3 Example of the application of the allocation principles

AusNet Services values its assets in accordance with an optimised replacement cost (ORC) methodology. In accordance with clause 6A.22.3(a), AusNet Services determines the *attributable cost share* for each *category of prescribed transmission services* by calculating the ratio of:

- (1) the ORC of the *transmission system* assets directly attributable to the provision of that *category of prescribed transmission services*; to
- (2) the total ORC of AusNet Services' *transmission system* assets and any other *transmission system* assets directly attributable to the provision of *prescribed transmission services*.

For example, if the ORCs of the *prescribed transmission assets* have been allocated to the applicable categories of *prescribed transmission services* as shown in the table below, then the *attributable cost shares* for entry assets are calculated as shown in the formula below:

$$\begin{aligned}
 \text{Attributable cost share}_{\text{Entry}} &= \text{ORC}_{\text{Entry}} \div \text{ORC}_{\text{Total}} \\
 &= \$2,875,000 \div \$104,460,000 \\
 &= 0.0275
 \end{aligned}$$

The *attributable cost shares* of the other categories of *prescribed transmission services* follow the same formula resulting in the *attributable cost shares* shown in the last column of the table.

Table 4.1: Step changes and zero-based costs

Category	ORC	Attributable cost share
Entry services	2,875,000	0.0275
Exit services	22,593,000	0.2163
TUOS services	68,992,000	0.6605
Common services	10,000,000	0.0957
Total	104,460,000	1.0000

5 Allocation of the ASRR to transmission network connection points

5.1 Overview of allocation principles

The next step in the *pricing methodology* is for AusNet Services to allocate the *ASRR* for each of *prescribed entry services* and *prescribed exit services* to *transmission network connection points*. This section of the proposed pricing methodology explains how that allocation is done.

It is noted that *AEMO* is responsible for allocating the *ASRR* for *prescribed TUOS services* and *prescribed common transmission services* in accordance with the *Rules*.

Clause 6A.23.3 sets out the following principles for allocating the *ASRR* to *transmission network connection points*:

- (a) The whole of the *ASRR* for *prescribed entry services* is to be allocated to *transmission network connection points* (other than connection points of any Market Network Service Provider) in accordance with the *attributable connection point cost share* for *prescribed entry services* that are provided by the *TNSP* at that *connection point*.
- (b) The whole of the *ASRR* for *prescribed exit services* is to be allocated to *transmission network connection points* (other than connection points of any Market Network Service Provider) in accordance with the *attributable connection point cost share* for *prescribed exit services* that are provided by the *TNSP* at that *connection point*.

Clause 6A.22.4 defines the attributable connection point cost share as follows:

- (a) For a *TNSP* for *prescribed entry services* and *prescribed exit services*, the *attributable connection point cost share* for that *TNSP* for each of those categories of services must substantially reflect the ratio of:
 - (1) the costs of the *transmission system* assets directly attributable to the provision of *prescribed entry services* or *prescribed exit services*, respectively, at a *transmission network connection point*; to
 - (2) the total costs of all the *TNSP's transmission system* assets directly attributable to the provision of *prescribed entry services* or *prescribed exit services*, respectively.
- (b) The costs of the *transmission system* assets referred to in paragraph (a) refer to optimised replacement cost or to an accepted equivalent to optimised replacement cost that is referable to values contained in the accounts of the *TNSP*.

5.2 Application of the allocation principles

In accordance with clause 6A.23.3, AusNet Services allocates the *ASRR* for *prescribed entry services* and *prescribed exit services* to *transmission network connection points* using the attributable connection point cost shares for *prescribed entry services* and *prescribed exit services* at each connection point. The attributable connection point cost shares are determined by calculating the ratio of:

- (1) the costs of the *transmission system* assets directly attributable to the provision of *prescribed entry services* or *prescribed exit services*, respectively, at a *transmission network connection point*; to
- (2) the total costs of all AusNet Services' *transmission system* assets directly attributable to the provision of *prescribed entry services* or *prescribed exit services*, respectively.

In calculating the costs used to calculate these ratios, AusNet Services values its assets in accordance with an ORC methodology.

The *Rules* do not specify any principles to address the allocation of costs to multiple customers at a single terminal station. Nevertheless, AusNet Services proposes the following standard allocation methodology for multiple customers at a single terminal station with its existing customers. Customers remain free to negotiate a different methodology with AusNet Services at any time. Any change in methodology will need to be agreed by all customers at a single terminal station.

5.2.1 Shared entry services

Where more than one entry customer shares a terminal station, shared costs will be allocated by directly allocated asset optimised replacement cost (ORC) share. For example, if Generator A has been allocated dedicated assets with an ORC value of \$3M and Generator B has been allocated dedicated assets with an ORC value of \$1M then the remaining shared assets ORC value will be allocated with a 75%/25% split respectively. An example showing the breakdown of assets undertaken in accordance with clauses 6A.22.4 and 6A.23.3 at an entry terminal station is illustrated in the figure below.

Figure 5.2.1: Entry terminal station example

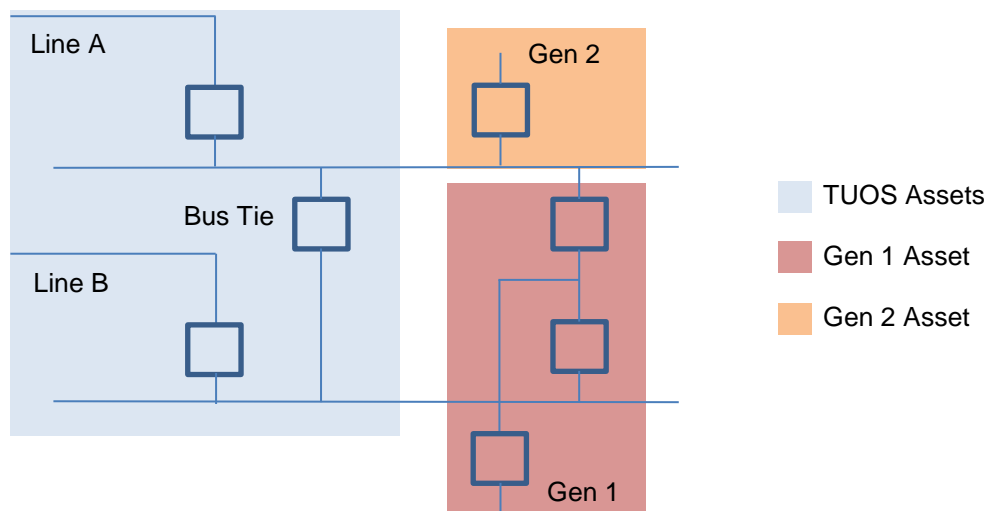

5.2.2 Shared exit services

Where more than one exit customer is supplied from a terminal station, shared costs will be allocated. At the date of preparing this pricing methodology, the coincident maximum demand (average of 10 highest demand days) will be used to determine the allocation of costs between customers at shared exit terminal stations².

- Adjustments to the coincident maximum demand will be made where a feeder is shared between two or more customers. This information and any adjustments necessary will be agreed by all customers connected to the relevant *connection point*;
- Coincident maximum demand information provided for the allocation will be based on the most up to date financial year data available. and
- The proportion of shared costs allocated to a new exit customer must be calculated on the basis of a reasonable estimate of expected demand (over a period of not less than six

² Reflects AEMO's 10MD approach as at 31 October 2020. This approach is currently under review and any changes may be adopted when it comes into effect.

months), consistent with the terms of the connection agreement between AusNet Services and the new exit customer.

AusNet Services will receive the required information from the relevant *Distribution Network Service Provider* as a percentage split for each shared terminal station. Non-distributor connection customers who share in use of prescribed connection assets will have identical consultation opportunities and be subject to identical allocation principles.

An example showing the breakdown of assets undertaken at an exit terminal station is illustrated in the figure below.

Figure 5.2.2: Exit terminal station example

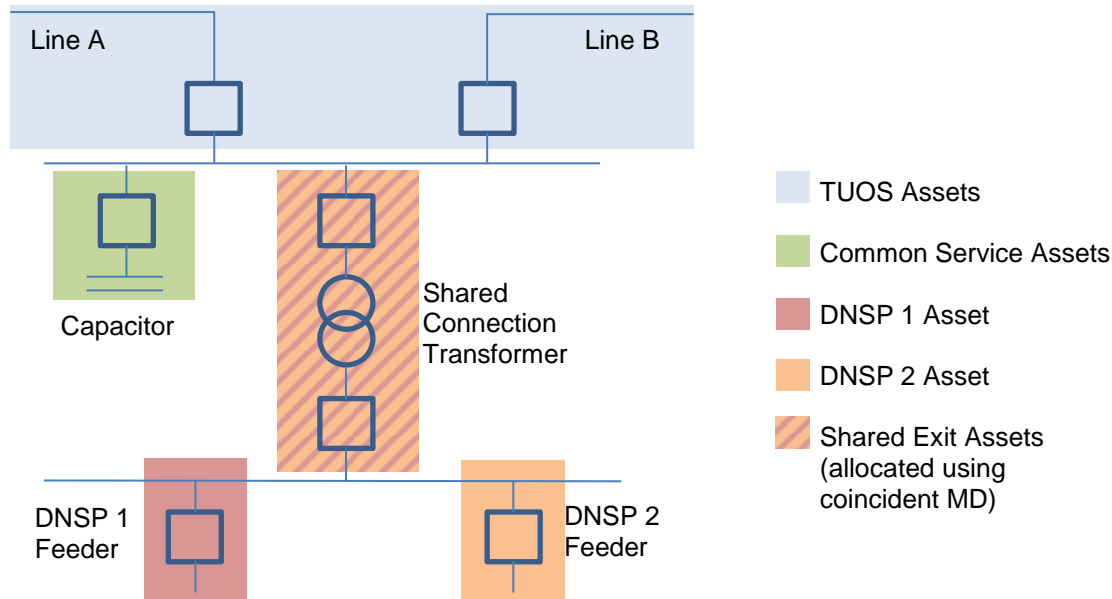

5.2.3 Shared exit and entry services

Where an exit customer shares a terminal station with a *Generator* or *Market Network Service Provider*, shared costs will be allocated by asset ORC share.

5.3 Recovery of the ASRR as prices

Clause 6A.23.4 requires a *TNSP* to develop prices for the recovery of the *ASRR* for Transmission Customers (but not *Market Network Service Providers*) for the relevant regulatory year to which the maximum allow revenue relates and in accordance with the principles set out in the clause. As noted earlier, AusNet Services is responsible for the pricing of *prescribed entry services* and *prescribed exit services* only, whilst *AEMO* has responsibility for pricing *prescribed TUOS services* and *prescribed common transmission services*.

In relation to *prescribed entry services* and *prescribed exit services*, clause 6A.23.4(g) requires that prices for *prescribed entry services* and *prescribed exit services* must be a fixed annual amount. In accordance with this *Rules* requirement, AusNet Services therefore proposes that prices for *prescribed entry services* and *prescribed exit services* are fixed annual amounts.

6 Information requirements and billing

6.1 Compliance with Rule 6A.27

Consistent with clause 6A.27.1:

- AusNet Services will calculate the transmission service charges payable by Transmission Network Users in accordance with the transmission service prices published under clause 6A.24.2.
- AusNet Services will issue a bill to Transmission Network Users for *prescribed transmission services*.
- Where the billing for a particular financial year is based on quantities which are undefined until after the commencement of the financial year, charges will be estimated from the previous year's billing quantities with a reconciliation to be made when the actual billing quantities are known and, where the previous year's billing quantities are unavailable or no longer suitable, nominated quantities may be used as agreed between the parties.
- Where charges are to be determined for *prescribed transmission services* from metering data, these charges will be based on kW or kWh obtained from the *metering data* managed by AEMO.

AusNet Services will issue invoices to *Transmission Network Users* for *prescribed transmission services* which satisfy or exceed the minimum information requirements specified in clause 6A.27.2 on a monthly basis or as otherwise agreed in the relevant transmission *connection agreement*.

Consistent with clause 6A.27.3, a *Transmission Network User* must pay charges for *prescribed transmission services* properly charged to it and billed in accordance with this proposed *pricing methodology* by the date specified in the invoice.

7 Prudential requirements

7.1 Prudential requirements for prescribed transmission services

As permitted by clause 6A.28.1, AusNet Services may require a *Transmission Network User* to establish *prudential requirements* for *connection services*. These *prudential requirements* may take the form of, but need not be limited to, capital contributions, prepayments or financial guarantees.

The requirements for such *prudential requirements* will be negotiated between the parties and specified in the applicable transmission *connection agreement*.

7.2 Capital contribution or prepayment for a specific asset

Consistent with clause 6A.28.2 of the *Rules*, where AusNet Services is required to construct or acquire specific assets to provide *prescribed connection services* to a *Transmission Network User*, AusNet Services may require the *Transmission Network User* to make a capital contribution or prepayment for all or part of the cost of the new assets installed.

In the event that a capital contribution is required, any contribution made will be taken into account in the determination of *prescribed transmission service* prices applicable to that *Transmission Network User* by way of a proportionate reduction in the ORC of the asset(s) used for the allocation of *prescribed transmission service* charges, or as otherwise negotiated between the parties.

In the event that a prepayment is required, any prepayment made will be taken into account in the determination of *prescribed transmission service* prices applicable to that *Transmission Network User* in a manner to be negotiated between the parties.

The treatment of such capital contributions or prepayments for the purposes of a *revenue determination* will, in all cases, be in accordance with the relevant provisions of the *Rules*.

Appendix A – Structure of transmission pricing in Victoria³

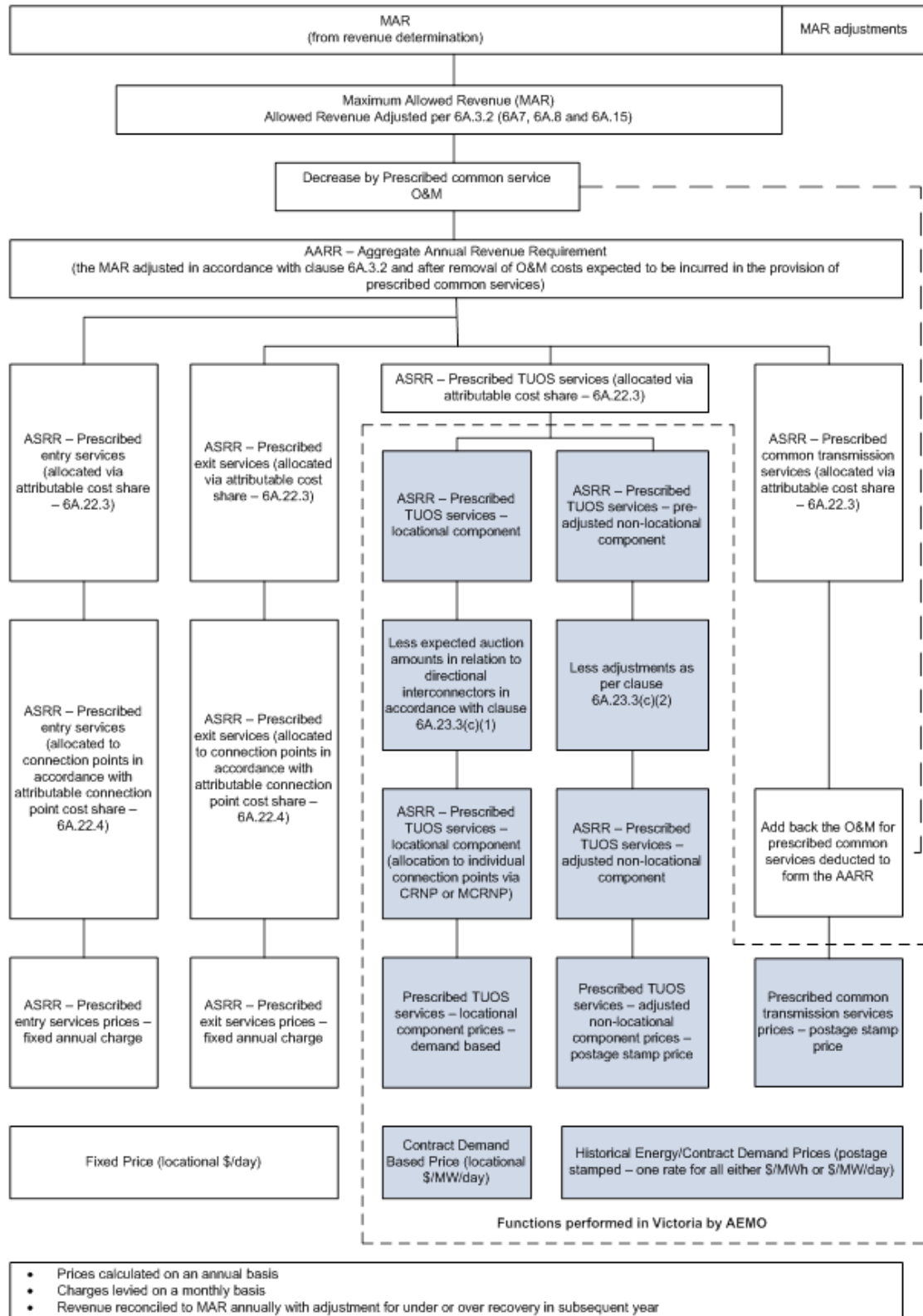

³ Reflects AEMO's pricing methodology as at 31 October 2020. This methodology is currently being reviewed and any changes will come into effect from 1 July 2022.

Appendix B – Priority ordering methodology

B.1 Rules requirements

Clause 6A.23.2 (d) of the Rules requires that:

Where, as a result of the application of the attributable cost share, a portion of the AARR would be attributable to more than one category of prescribed transmission services, that attributable cost share is to be adjusted and applied such that any costs of a transmission system asset that would otherwise be attributed to the provision of more than one category of prescribed transmission services, is allocated as follows:

- (1) to the provision of prescribed TUOS services, but only to the extent of the stand-alone amount for that category of prescribed transmission services;
- (2) if any portion of the costs of a transmission system asset is not allocated to prescribed TUOS services, under subparagraph (1), that portion is to be allocated to prescribed common transmission services, but only to the extent of the stand-alone amount for that category of prescribed transmission services; and
- (3) if any portion of the costs of a transmission system asset is not attributed to prescribed transmission services under subparagraphs (1) and (2), that portion is to be attributed to prescribed entry services and prescribed exit services.

Stand-alone amount is defined as:

For a category of prescribed transmission services, the costs of a transmission system asset that would have been incurred had that transmission system asset been developed, exclusively to provide that category of prescribed transmission services.

Transitional Rule 11.6.11(c) states the following:

“For the purposes of new Chapter 6A:

- (1) the costs of the transmission system assets that from time to time may be treated as:
 - (i) directly attributable to the provision of a prescribed connection service; or
 - (ii) incurred in providing a prescribed connection service,to a Transmission Network User or a group of Transmission Network Users at a transmission network connection point is limited to the costs of the eligible assets which, from time to time, provide that prescribed connection service;
- (2) any costs of an existing asset or a replacement asset (or of any portion of an existing asset or a replacement asset) that:
 - (i) is not an eligible asset (other than as a result of clause 11.6.11(d)); and
 - (ii) is used by a TNSP to provide connection services to a Transmission Network User or a group of Transmission Network Users at a transmission network connection point, must be treated as costs that are directly attributable to the provision of, or are incurred in providing, prescribed TUOS services and, to avoid doubt, the services provided by those assets which would otherwise be connection services are taken to be prescribed TUOS services; and
- (3) the stand-alone amount for prescribed TUOS services is taken to include any portion of the costs referred to in clause 11.6.11(c)(2) that has not been allocated under clause 6A.23.2(d)(1).”

This transitional provision effectively introduces a fourth step to the priority ordering requirement.

B.2 Objective and general approach

The allocation methodology relies on the assumption that terminal station infrastructure and establishment costs are proportionate to the number of circuit breakers in the terminal station.

Based on this assumption the appropriate allocator for terminal station infrastructure and establishment costs for a stand-alone arrangement is the ratio of the number of circuit breakers in the stand-alone arrangement to the number of circuit breakers in the whole terminal station.

B.3 Proposed methodology

Step 1: Branch Identification

Identify the branches, being the lines, transformers, major reactive devices and exits / entries in the terminal station which provide prescribed TUOS services, prescribed common transmission services and prescribed exit services or prescribed entry services, in the terminal station.

Step 2: Allocation of circuit breakers to branches

For each high voltage circuit breaker in the terminal station identify the branches directly connected to it. Any circuit breaker that does not directly connect to a branch is excluded from allocation and all costs associated with it are added to the terminal station infrastructure and establishment cost.

Count the total number of circuit breakers directly connected to branches.

Distribution Network Service Providers (DNSPs) are classified as a prescribed exit service while Generators are classified as a prescribed entry service. Negotiated transmission services are not part of the regulated asset base and fall outside the priority ordering process detailed in clause 6A.23.2(d) of the Rules.

Step 3.1: Stand-alone arrangements for prescribed TUOS services

With reference to the number of lines providing prescribed TUOS services determine the number of circuit breakers required to provide prescribed TUOS services of an equivalent standard on a stand-alone basis. The stand-alone configuration is the simplest terminal station configuration (in the absence of development) had it been developed to provide a prescribed TUOS service. This may be done by way of a look up of typical stand-alone configurations.

Step 3.2: Stand-alone arrangements for prescribed common transmission services

With reference to the number of lines providing prescribed TUOS services and the devices providing prescribed common transmission service determine the number of circuit breakers required to provide prescribed common transmission services of an equivalent standard on a stand-alone basis. The stand-alone configuration is the simplest terminal station configuration (in the absence of development) had it been developed to provide a prescribed common transmission service. This may be done by way of a look up of typical stand-alone configurations.

Step 4: Allocation of terminal station infrastructure and establishment costs

Step 4.1 – Allocation of prescribed TUOS services

Allocate a portion of terminal station infrastructure and establishment costs to prescribed TUOS services according to the ratio of the high voltage circuit breakers identified in step 3.1 to the total number of high voltage circuit breakers connected to branches in the terminal station identified in step 2.

Step 4.2 – Calculation of the unallocated terminal station infrastructure costs (after prescribed TUOS services allocation)

Calculate the unallocated terminal station infrastructure cost (after prescribed TUOS services allocation) by subtracting the amount calculated in step 4.1 from the total terminal station infrastructure amount.

Step 4.3 – Allocation of prescribed common transmission services

Allocate a portion of the terminal station infrastructure and establishment costs to prescribed common transmission services based on to the ratio of the high voltage circuit breakers providing prescribed common transmission services identified in step 3.2 to the total number of high voltage circuit breakers connected to branches in the terminal station. If the prescribed common transmission services portion of terminal station infrastructure is greater than the unallocated costs, then the unallocated portion only is attributed to prescribed common transmission services. In this instance, nothing will be attributed to prescribed entry services and prescribed exit services.

Step 4.4 – Calculation of the unallocated terminal station infrastructure costs (after prescribed common transmission services allocation)

Calculate the unallocated terminal station infrastructure cost (after prescribed common transmission services allocation) by subtracting the amount calculated in step 4.3 from the amount calculated in step 4.2.

Step 4.5 – Allocation of prescribed entry and exit service costs to Prescribed TUOS services per clause 11.6.11

Allocate the remaining terminal station infrastructure and establishment costs (calculated in step 4.4) to each branch providing prescribed TUOS services based on the ratio of the high voltage circuit breakers providing the prescribed TUOS services to the branch to the total number of high voltage circuit breakers providing prescribed TUOS services or in accordance with the cost allocation process in section 4 of this Pricing Methodology as appropriate.

Notes

Costs are only allocated in step 4 until fully allocated.

Consistent with clause 6A.23.2(d)(3) of the Rules it is possible that no costs will be attributed to prescribed entry services and prescribed exit services.

New and existing negotiated transmission service assets are excluded from the analysis as any incremental establishment costs associated with them are taken to be included in the negotiated transmission services charges on a causation basis.

The assessment of standalone arrangements only needs to be conducted once per terminal station except where changes to the configuration of the terminal station occur.

B.4 Definition - Branches

As illustrated by the diagrams below a “Branch” is a collection of assets (e.g. lines, circuit breakers, capacitors, buses and *transformers*) that provide a *transmission service*.

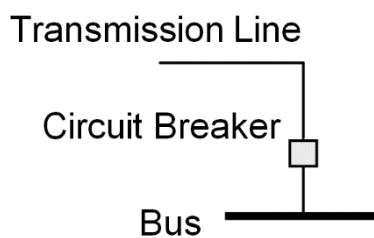

Branch with transmission line, bus and circuit breaker

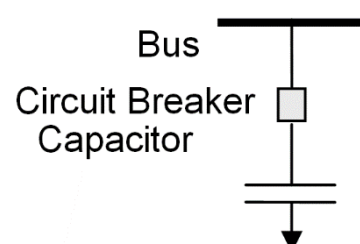

Branch with capacitor, circuit breaker and bus

B.5 Examples

B.5.1 Example A

Terminal station configuration

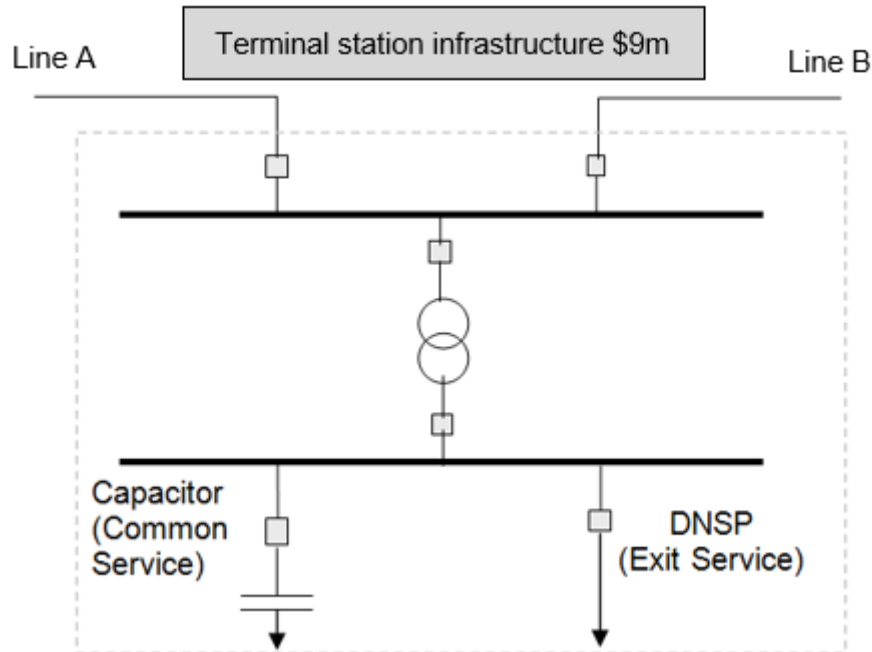

- Step 1:** The branches are Line A, Line B, DNSP, tie transformer and *prescribed common transmission services*.
- Step 2:** The total number of circuit breakers directly *connected* to branches is 6.
- Step 3.1:** The stand-alone arrangement for the provision of *prescribed TUOS services* to an equivalent standard is shown below and consists of 2 circuit breakers.

Stand-alone prescribed TUOS services

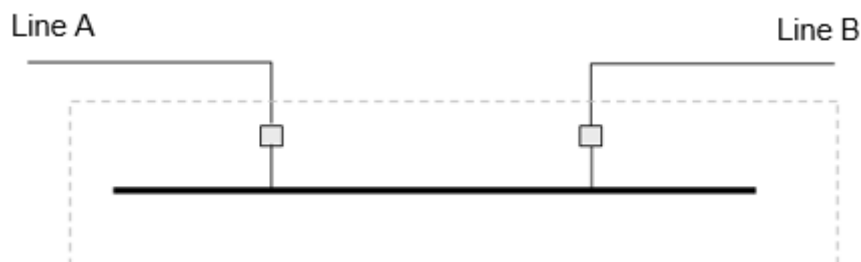

- Step 3.2:** The stand-alone arrangement for the provision of *prescribed common transmission services* to an equivalent standard is shown below and consists of 3 circuit breakers.

Stand-alone prescribed common transmission services

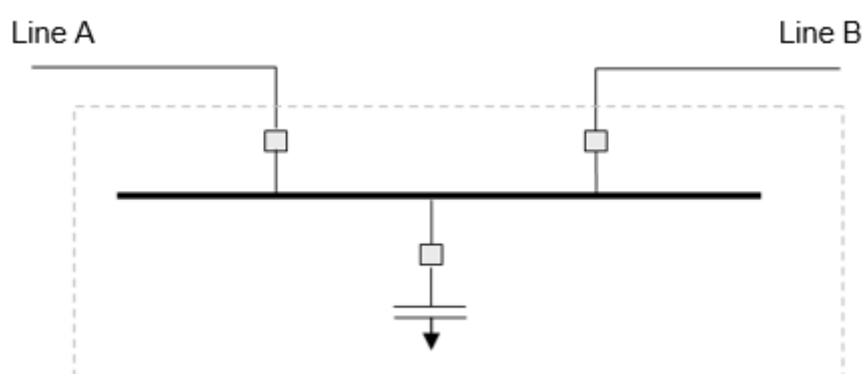
**Step 4:**

Assume total Infrastructure cost is \$9m.

Costs are allocated to *prescribed TUOS services* in the ratio of the circuit breakers in the stand-alone arrangement to the total circuit breakers.

Infrastructure cost allocated to *prescribed TUOS services* (a) = $(2 \div 6) \times \$9\text{m} = \3m

Unallocated terminal station infrastructure costs (after *prescribed TUOS services* allocation) = $\$9\text{m} - \$3\text{m} = \$6\text{m}$

Costs are allocated to *prescribed common transmission services* in the ratio of the circuit breakers in the stand-alone arrangement to the total circuit breakers.

Infrastructure cost allocated to *prescribed common transmission services* = $(3 \div 6) \times \$9\text{m} = \4.5m

Unallocated terminal station infrastructure costs (after *prescribed common transmission services* allocation) = $\$6\text{m} - \$4.5\text{m} = \$1.5\text{m}$

Remainder of unallocated (calculated above) to be allocated to *prescribed TUOS services* per clause 11.6.11 of the *Rules*.

Infrastructure cost allocated to *prescribed TUOS services* (b) = \$1.5m

Table B.5.1: Example A cost breakdown

Item	Number	Allocation	Unallocated
Terminal station infrastructure costs		9,000,000	9,000,000
Total breakers	6		
TUOS stand-alone breakers	2		
Share to TUOS (a)	0.333	3,000,000	6,000,000
Common services stand-alone breakers	3		
Share to common services	0.500	4,500,000	1,500,000
Share to TUOS (b)		1,500,000	
Total share to TUOS (a) + (b)		4,500,000	
Total share to common services		4,500,000	

B.5.2 Example B

Terminal station configuration

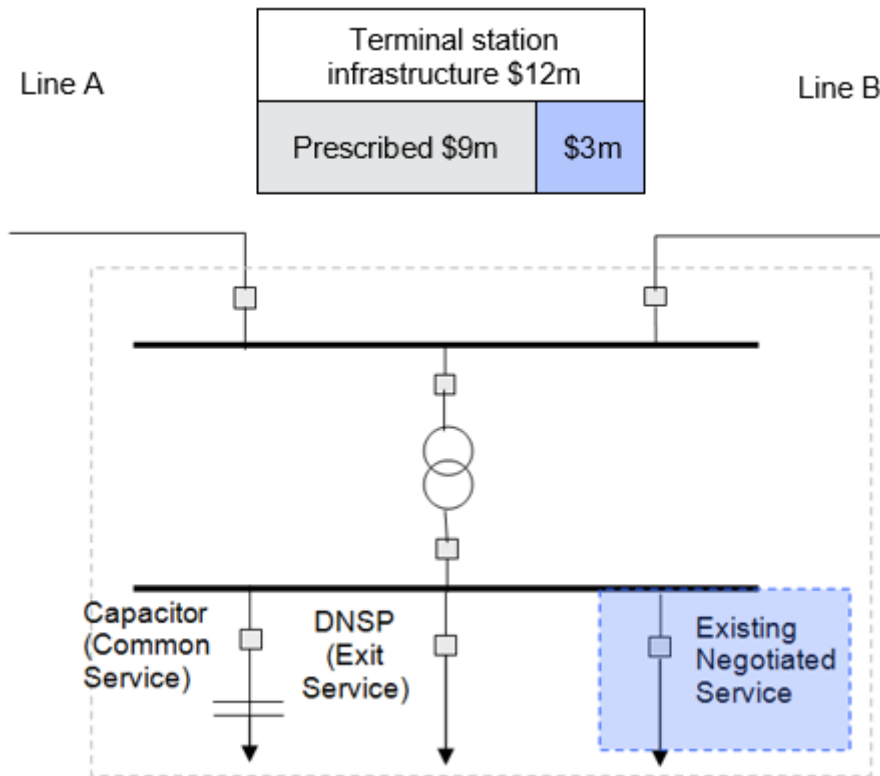

Step 1:

The branches are Line A, Line B, DNSP, tie transformer, *prescribed common transmission services* and an existing negotiated service.

Step 2:

The total number of circuit breakers directly *connected* to branches is 6 (no prescribed costs are allocated to the existing *negotiated transmission services*).

Step 3.1:

The stand-alone arrangement for the provision of *prescribed TUOS services* to an equivalent standard is shown below and consists of 2 circuit breakers.

Stand-alone prescribed TUOS services



Step 3.2:

The stand-alone arrangement for the provision of *prescribed common transmission services* to an equivalent standard is shown below and consists of 3 circuit breakers.

Stand-alone prescribed common transmission services

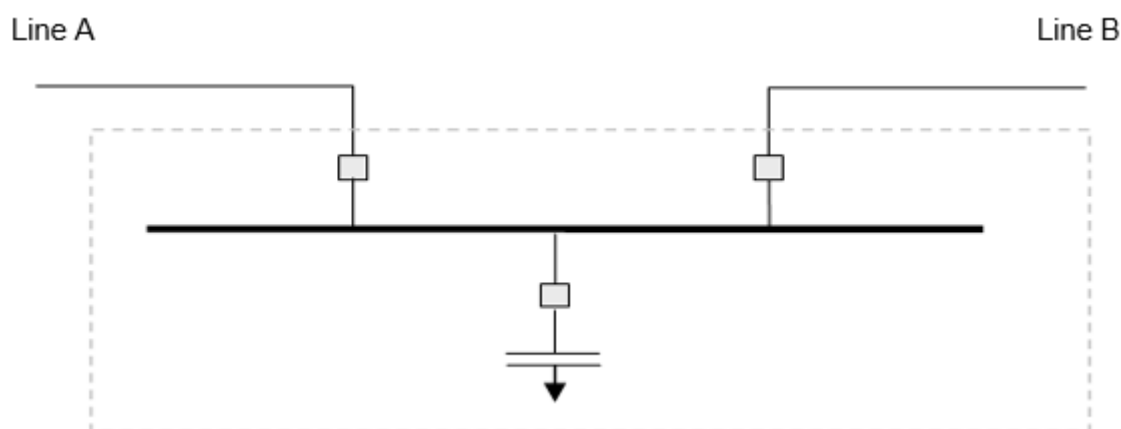

Step 4:

Assume total infrastructure cost is \$12m, however \$3m is for the existing *negotiated transmission service*, which does not form part of the regulated asset base and is not governed by clause 6A.23.2(d) of the *Rules*.

Costs are allocated to *prescribed TUOS services* in the ratio of the circuit breakers in the stand-alone arrangement to the total circuit breakers.

Infrastructure cost allocated to *prescribed TUOS services* (a) = $(2 \div 6) \times \$9m = \$3m$

Unallocated terminal station infrastructure costs (after *prescribed TUOS services* allocation) = $\$9m - \$3m = \$6m$

Costs are allocated to *prescribed common transmission services* in the ratio of the circuit breakers in the stand-alone arrangement to the total circuit breakers.

Infrastructure cost allocated to *prescribed common transmission services* = $(3 \div 6) \times \$9m = \$4.5m$

Unallocated terminal station infrastructure costs (after *prescribed common transmission services* allocation) = $\$6m - \$4.5m = \$1.5m$

Remainder of unallocated (calculated above) to be allocated to *prescribed TUOS services*.

Infrastructure cost allocated to *prescribed TUOS services* (b) = \$1.5m

Table B.5.2: Example B cost breakdown

Item	Number	Allocation	Unallocated
Terminal station infrastructure costs		9,000,000	9,000,000
Total breakers	6		
TUOS stand-alone breakers	2		
Share to TUOS (a)	0.333	3,000,000	6,000,000
Common services stand-alone breakers	3		
Share to common services	0.500	4,500,000	1,500,000
Share to TUOS (b)		1,500,000	
Total share to TUOS (a) + (b)		4,500,000	

Item	Number	Allocation	Unallocated
Total share to common services		4,500,000	

B.5.3 Example C

Terminal station configuration

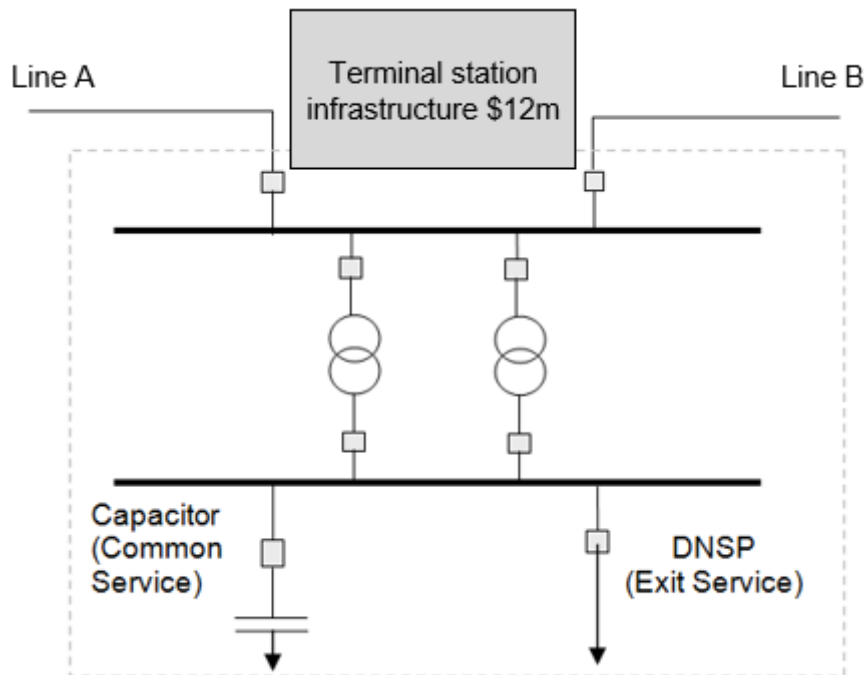

Step 1:

The branches are Line A, Line B, DNSP, tie transformer 1, tie transformer 2 and *prescribed common transmission service*.

Step 2:

The total number of circuit breakers directly *connected* to branches is 8.

Step 3.1:

The stand-alone arrangement for the provision of *prescribed TUOS services* to an equivalent standard is shown below and consists of 2 circuit breakers.

Stand-alone prescribed TUOS services



Step 3.2:

The stand-alone arrangement for the provision of *prescribed common transmission services* to an equivalent standard is shown below and consists of 3 circuit breakers.

Stand-alone prescribed common transmission services

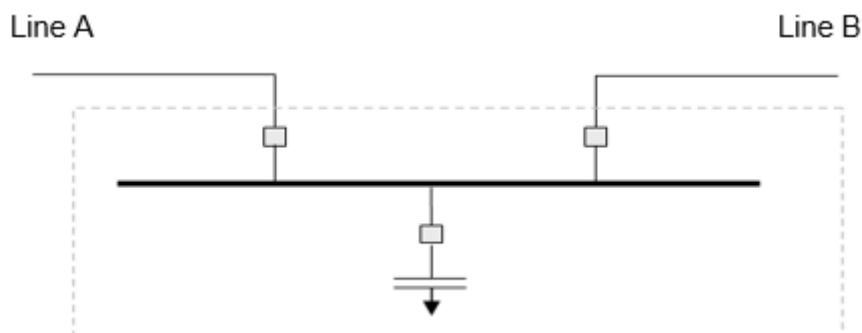

Step 4:

Assume total Infrastructure cost is \$12m.

Costs are allocated to *prescribed TUOS services* in the ratio of the circuit breakers in the stand-alone arrangement to the total circuit breakers.

Infrastructure cost allocated to *prescribed TUOS services* (a) = $(2 \div 8) \times \$12\text{m} = \3m

Unallocated terminal station infrastructure costs (after *prescribed TUOS services* allocation) = $\$12\text{m} - \$3\text{m} = \$9\text{m}$

Costs are allocated to *prescribed common transmission services* in the ratio of the circuit breakers in the stand-alone arrangement to the total circuit breakers.

Infrastructure cost allocated to *prescribed common transmission services* = $(3 \div 8) \times \$12\text{m} = \4.5m

Unallocated terminal station infrastructure costs (after *prescribed common transmission services* allocation) = $\$9\text{m} - \$4.5\text{m} = \$4.5\text{m}$

Remainder of unallocated (calculated above) to be allocated to *prescribed TUOS services*.

Infrastructure cost allocated to *prescribed TUOS services* (b) = \$4.5m

Table B.5.3: Example C cost breakdown

Item	Number	Allocation	Unallocated
Terminal station infrastructure costs		12,000,000	12,000,000
Total breakers	8		
TUOS stand-alone breakers	2		
Share to TUOS (a)	0.250	3,000,000	9,000,000
Common services stand-alone breakers	3		
Share to common services	0.375	4,500,000	4,500,000
Share to TUOS (b)		4,500,000	
Total share to TUOS (a) + (b)		7,500,000	
Total share to common services		4,500,000	

B.5.4 Example D

Terminal station configuration

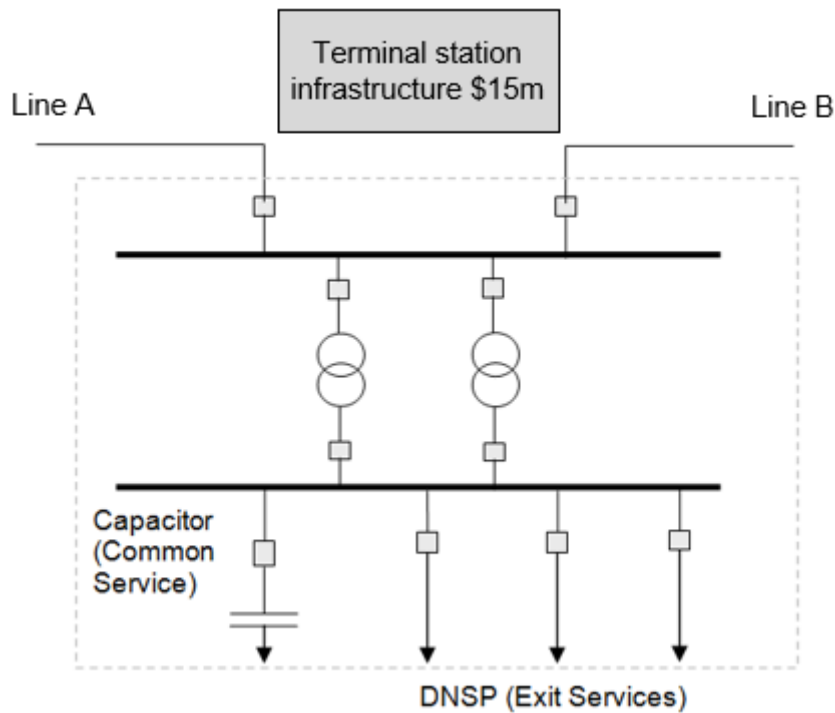

Step 1:

The branches are Line A, Line B, *DNSP1*, *DNSP2*, *DNSP3*, tie transformer 1, tie transformer 2 and PCS.

Step 2:

The total number of circuit breakers directly *connected* to branches is 10.

Step 3.1:

The stand-alone arrangement for the provision of *prescribed TUOS services* to an equivalent standard is shown below and consists of 2 circuit breakers.

Stand-alone prescribed TUOS services



Step 3.2:

The stand-alone arrangement for the provision of *prescribed common transmission services* to an equivalent standard is shown below and consists of 3 circuit breakers.

Stand-alone prescribed common transmission services

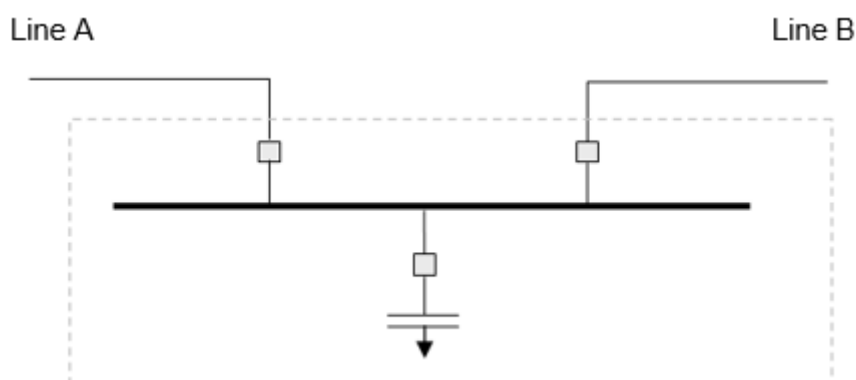
**Step 4:**

Assume total Infrastructure cost is \$15m.

Costs are allocated to *prescribed TUOS services* in the ratio of the circuit breakers in the stand-alone arrangement to the total circuit breakers.

Infrastructure cost allocated to *prescribed TUOS services* (a) = $(2 \div 10) \times \$15\text{m} = \3m

Unallocated terminal station infrastructure costs (after *prescribed TUOS services* allocation) = $\$15\text{m} - \$3\text{m} = \$12\text{m}$

Costs are allocated to *prescribed common transmission services* in the ratio of the circuit breakers in the stand-alone arrangement to the total circuit breakers.

Infrastructure cost allocated to *prescribed common transmission services* = $(3 \div 10) \times \$15\text{m} = \4.5m

Unallocated terminal station infrastructure costs (after *prescribed TUOS services* allocation) = $\$12\text{m} - \$4.5\text{m} = \$7.5\text{m}$

Remainder of unallocated (calculated above) to be allocated to *prescribed TUOS services*.

Infrastructure cost allocated to *prescribed TUOS services* (b) = \$7.5m

Table B.5.4: Example D cost breakdown

Item	Number	Allocation	Unallocated
Terminal station infrastructure costs		15,000,000	15,000,000
Total breakers	10		
TUOS stand-alone breakers	2		
Share to TUOS (a)	0.200	3,000,000	12,000,000
Common services stand-alone breakers	3		
Share to common services	0.300	4,500,000	7,500,000
Share to TUOS (b)		7,500,000	
Total share to TUOS (a) + (b)		10,500,000	
Total share to common services		4,500,000	