



Proposed Pricing Methodology

1 July 2009 to 30 June 2014

January 2009

TransGrid is the principal electricity transmission network service provider (TNSP) in New South Wales.

At TransGrid we:

- Recognise that a strong and reliable electricity transmission system is important to the NSW and national economies and future security of supply
- Respond appropriately to our customers' needs
- Provide required electricity transmission services efficiently and prudently
- Take stakeholder views into consideration as a key aspect of prudent practice

For information about TransGrid visit <http://www.transgrid.com.au/>

Contact

For enquiries about this proposed pricing methodology please contact:

Philip Gall
Manager/Regulated Transmission Access
TransGrid

email: phil.gall@transgrid.com.au

Table of Contents

1. Introduction	1
2. Interpretation	1
3. Prescribed Transmission Services	1
4. Rules Requirements	2
5. Pricing Methodology Guidelines Requirements	2
6. Proposed Pricing Methodology	4
6.1 Background.....	4
6.2 Co-ordinating Network Service Provider	4
6.3 Aggregate Annual Revenue Requirement.....	4
6.4 Categories of transmission services.....	5
6.5 Cost allocation	5
6.5.1 Assets attributable to prescribed entry services and prescribed exit services ...	6
6.6 Calculation of the attributable cost share for each category of service.....	6
6.7 Calculation of the Annual Service Revenue Requirement (ASRR).....	7
6.8 Allocation of the ASRR to transmission network connection points.....	8
6.8.1 Prescribed entry services	8
6.8.2 Prescribed exit services.....	9
6.8.3 Prescribed Transmission Use of System (TUOS) services.....	10
6.8.4 Load and generation data.....	11
6.8.5 Network support costs	12
6.9 Transmission prices and charges.....	12
6.9.1 Prescribed entry and exit services prices	12
6.9.2 Prescribed TUOS services – locational component prices and charges	12
6.9.3 Prescribed TUOS services – non-locational component prices and charges .	13
6.10 Prescribed common service prices and charges.....	15
6.11 Excess demand charge	15
6.12 Setting of TUOS locational prices between annual price publications.....	16
7. Billing Arrangements	16
7.1 Billing for prescribed transmission services.....	16
7.2 Payments between Transmission Network Service Providers.....	16
8. Prudential Requirements	17
8.1 Prudential requirements for prescribed transmission services.....	17
8.2 Capital contribution or prepayment for a specific asset.....	17
9. Giving Effect to National Electricity Rules Pricing Principles	17
10. Prudent Discounts	17
11. Monitoring and Compliance	18
12. Description of Pricing Methodology Differences	18



12.1 Removal of Peak and Shoulder Average Demand Rates from Locational Charges
18

12.2 Costs that could be allocated to more than one category of service..... 19

12.3 Provision for relaxation of TUOS locational side constraints..... 19

13. Additional information requirements..... 19

14. Conclusion..... 20

Appendix A - Structure of Transmission Pricing under Part J of Rules..... 21

Appendix B - Cost Reflective Network Pricing Methodology 22

Appendix C - Priority Ordering Methodology 24

AEMC Rule determination 24

Objective and General Approach..... 25

Proposed Methodology 25

Step 1: Branch Identification..... 25

Step 2: Allocation of Circuit Breakers to Branches..... 25

Step 3.1: Stand-alone arrangements for Prescribed TUOS 26

Step 3.2: Stand-alone arrangements for Prescribed common transmission services 26

Step 4: Allocation of substation infrastructure and establishment costs 26

Notes 27

Definition - Branches..... 27

Examples 28

1. Introduction

TransGrid is the principal electricity *Transmission Network Service Provider* (TNSP) in New South Wales.

This proposed *pricing methodology*, for the regulatory period from 1 July 2009 to 30 June 2014, is submitted to the Australian Energy Regulator (AER) in accordance with the requirements of Chapter 6A of the National Electricity Rules (the Rules) and the AER's *pricing methodology guidelines*.

2. Interpretation

All terms in this proposed *pricing methodology* that are italicised have the meaning given to them in the *pricing methodology guidelines* or, where no definition is provided in that document, the Rules.

A reference to the Rules is taken to be a reference to the current version of the National Electricity Rules, version 20, which commenced operation on 1 May 2008 as amended from time to time.

A reference to the old Rules is taken to be a reference to version 9 of the National Electricity Rules which was operative between 27 July 2006 and 15 November 2006.

3. Prescribed Transmission Services

TransGrid's proposed *pricing methodology* relates to the provision of *prescribed transmission services* in the New South Wales region by TransGrid, Energy Australia, Country Energy, and Directlink.¹ These services include:

- Shared transmission services provided to customers directly connected to the transmission network and connected network service providers (*prescribed TUOS services*);
- Connection services provided to connect the distribution networks of Energy Australia, Integral Energy, Country Energy and ActewAGL to the transmission network (*prescribed exit services*);
- Connection services provided to generators and customers directly connected to the transmission network that are required to be treated as '*prescribed services*' in accordance with Clause 11.6.11 of the Rules (as amended from time to time) ; and
- Services required under the Rules or in accordance with jurisdictional electricity legislation and other regulatory requirements that are necessary to ensure the integrity of the transmission network, including through the maintenance of power

¹ In accordance with clause 6A.29.1 of the Rules, TransGrid is the *co-ordinating network service provider* for New South Wales and administers the allocation of the revenue entitlement for TransGrid, Energy Australia and Directlink Transmission Company's regulated revenue entitlement via TransGrid's transmission services prices.

system security and assisting in the planning of the power system (*prescribed common transmission services*).

For the avoidance of doubt the proposed *pricing methodology* does not relate to the provision of *negotiated transmission services*, or other *transmission services* provided by TransGrid that are not subject to economic regulation under Chapter 6A of the Rules.

4. Rules Requirements

Clause 6A.24.1 of the Rules states that the *pricing methodology* is a methodology, formula, process or approach that when applied by a TNSP:

- (1) allocates the *aggregate annual revenue requirement (AARR)* for *prescribed transmission services* to:
 - (i) the *categories of prescribed transmission services* for that provider; and
 - (ii) *transmission network connection points of Transmission Network Users*; and
- (2) determines the structure of the prices that a *Transmission Network Service Provider* may charge for each of the *categories of prescribed transmission services* for that provider.

The Rules also require that the *pricing methodology* satisfies principles and guidelines established by the Rules. In particular, clause 6A.10.1(e) of the Rules requires that the proposed *pricing methodology* must:

- (1) give effect to and be consistent with the *Pricing Principles for Prescribed Transmission Services* (that is to say, the principles set out in rule 6A.23); and
- (2) comply with the requirements of, and contain or be accompanied by such information as is required by, the *pricing methodology guidelines* made for that purpose under rule 6A.25.

5. Pricing Methodology Guidelines Requirements

The *pricing methodology guidelines* supplement and elaborate on the pricing principles contained in Chapter 6A of the Rules in so far as they specify or clarify:

- the information that is to accompany a proposed *pricing methodology*;
- permitted pricing structures for the recovery of the locational component of providing *prescribed TUOS services*;
- permitted postage stamp pricing structures for *prescribed common transmission services* and the recovery of the adjusted non-locational component of providing *prescribed TUOS services*;

- the types of *transmission system* assets that are *directly attributable* to each category of *prescribed transmission services*; and
- those parts of a proposed *pricing methodology*, or the information accompanying it that will not be publicly disclosed without the consent of the TNSP.

TransGrid's existing and proposed *pricing methodologies* are permissible under the *pricing methodology guidelines*. The permissible features include:

- Calculation of the locational component of *prescribed TUOS services* costs using the *cost reflective network pricing methodology*; and
- The postage stamp pricing structures for the non-locational component of *prescribed TUOS services* and *prescribed common transmission services* being based on *contract agreed maximum demand* or historical energy.

The material additional requirements which arise from the *pricing methodology guidelines* include the requirement to:

- Detail the methodology for implementation of the priority ordering approach under clause 6A.23.2(d) of the Rules including a worked example;
- Describe how asset costs allocated to *prescribed entry services* and *prescribed exit services* at a connection point, which may be attributable to multiple *transmission network users*, will be allocated;
- Detail billing arrangements as outlined in clause 6A.27 of the Rules;
- Detail prudential requirements as outlined in clause 6A.28 of the Rules;
- Provide specified hypothetical worked examples; and
- Detail on how TransGrid intends to monitor and develop records of its compliance with its approved *pricing methodology*, the pricing principles for *prescribed transmission services* (clause 6A.23) and part J of the Rules in general.

6. Proposed Pricing Methodology

6.1 Background

TransGrid's transmission *pricing methodology*, applicable from 1 July 2004, was developed in accordance with Part C of Chapter 6 of the old Rules.

The diagram in Appendix A outlines the structure of transmission pricing under part J of the Rules that is applicable to this proposed *pricing methodology*.

6.2 Co-ordinating Network Service Provider

In accordance with clause 6A.29.1 of the Rules, TransGrid is the *Co-ordinating Network Service Provider* for New South Wales and collects prescribed revenue entitlements for TransGrid, Energy Australia's prescribed transmission services, and the Directlink Transmission Company (Directlink) via TransGrid's prescribed transmission service prices.

Energy Australia and Directlink are required to advise TransGrid annually of the Aggregate Annual Revenue Requirement (*AARR*) for their *transmission system* assets which are used to provide *prescribed transmission services* within the New South Wales region. They are also required to provide any other information reasonably required by TransGrid to ensure the proper calculation of prescribed transmission prices in New South Wales².

6.3 Aggregate Annual Revenue Requirement

The revenue that a TNSP may earn in any regulatory year of a regulatory control period from the provision of *prescribed transmission services* is known as the *maximum allowed revenue*³.

The *AARR* is calculated in accordance with clause 6A.22.1 of the Rules as:

“the *maximum allowed revenue* referred to in clause 6A.3.1 adjusted:

- (1) in accordance with clause 6A.3.2, and
- (2) by subtracting the operating and maintenance costs expected to be incurred in the provision of *prescribed common transmission services*.”

Adjustments in accordance with clause 6A.3.2 could relate to a number of factors including reopening of the revenue determination for capital expenditure, network support pass through, cost pass through, service target performance incentive scheme outcomes and contingent projects.

The costs referred in (2) above are derived from budget projections and include:

- network switching and operations;

² This obligation will also apply to any additional *appointing providers* requiring the services of the *co-ordinating network service provider* during the life of this *pricing methodology*.

³ Clause 6A3.1 of the Rules.

- administration and management of the business;
- network planning and development; and
- general overheads.

6.4 Categories of transmission services

The AARRs for TransGrid, Energy Australia, and Directlink are recovered from transmission charges for the following categories of transmission services:

- *Prescribed entry services* which are provided by assets that are directly attributable to serving a Generator, or group of Generators, at a single connection point and are deemed prescribed by virtue of the operation of clause 11.6.11 of the Rules;
- *Prescribed exit services* which are provided by assets that are directly attributable to serving a Transmission Customer, or group of Transmission Customers, at a single connection point and: (a) are deemed prescribed by virtue of the operation of clause 11.6.11 of the Rules; or (b) are provided to Network Service Providers at the boundary of the prescribed transmission network;
- *Prescribed transmission use of system (TUOS) services* which are provided by assets that are shared to a greater or lesser extent by all users across the *transmission system* and are not *prescribed common transmission services*, *prescribed entry services* or *prescribed exit services*; and
- *Prescribed common transmission services*, which are services that benefit all Transmission Customers and cannot be reasonably allocated on a locational basis.

6.5 Cost allocation

The first step in calculating prescribed transmission service prices is to allocate the costs of *transmission system* assets to the categories of transmission service in section 6.4 above to the extent to which assets are *directly attributable* to the provision of a category of *prescribed transmission services*.

The delineation between the assets that provide *prescribed entry services*, *prescribed exit services*, *prescribed TUOS services* and *prescribed common transmission services* is set out in clause 2.4 of the *pricing methodology guidelines*.

In the case of those costs which would be attributable to more than one category of *prescribed transmission services*, costs will be allocated in accordance with the provisions of clause 6A.23.2(d) of the Rules having regard to the stand alone costs associated with the provision of *prescribed TUOS services* and *prescribed common transmission services* with the remainder being allocated to *prescribed entry services* and *prescribed exit services*. The implementation of the priority ordering process is detailed in Appendix CC.



6.5.1 Assets attributable to prescribed entry services and prescribed exit services

In the case of a shared connection asset (such as a transformer) serving multiple transmission connection points, which may provide both *prescribed entry services* and *prescribed exit services*, the cost of the shared connection asset will be allocated to the appropriate category or categories of *prescribed transmission services* using an appropriate causal cost allocator.

If there are multiple generators connected at the one connection point, then the entry cost would be allocated between the generators on the basis of the peak generation into the system by each generator. TransGrid does not currently have any connection points where this occurs.

If there are multiple customers connected at the one connection point, then the exit asset cost is allocated between the customers on the basis of the peak load measured for each customer in the most recent completed financial year. This arrangement currently applies at some points where two distributors share a connection point.

TransGrid does not currently have any connection points which provide both generator entry and customer exit services to different TransGrid customers.

6.6 Calculation of the attributable cost share for each category of service

The second step in calculating prescribed transmission service prices is the calculation of the attributable cost shares. The attributable cost share for each category of service is calculated in accordance with clause 6A.22.3 of the Rules as the ratio of:

- the costs of the *transmission system assets directly attributable* to the provision of that category of *prescribed transmission services* (as determined in section 6.5 above); to
- the total costs of all the TNSP’s *transmission system assets directly attributable* to the provision of *prescribed transmission services* (as determined in section 6.5 above).

For example, if the ORC’s of prescribed services assets have been allocated to the applicable categories of *prescribed transmission services* as shown in Table 1 then the attributable costs shares are calculated as:

$$\begin{aligned}
 \text{Attributable cost share}_{\text{EXIT}} &= \text{ORC}_{\text{EXIT}} / \text{ORC}_{\text{TOTAL}} \\
 &= \$6,972,222 / \$43,050,000 \\
 &= 0.162
 \end{aligned}$$

with the attributable cost shares of the other categories calculated in the same manner, as shown in Table 2.

Table 1: Costs allocated to categories of prescribed transmission services

Category	ORC
Exit service	6,972,222
Entry service	1,761,111
TUOS service	33,566,667
Common Service	750,000
Total	43,050,000

Table 2: Attributable cost shares

Category	ORC	Attributable cost share
Exit service	6,972,222	0.162
Entry service	1,761,111	0.041
TUOS service	33,566,667	0.780
Common Service	750,000	0.017
Total	43,050,000	1.000

6.7 Calculation of the Annual Service Revenue Requirement (ASRR)

The third step in calculating prescribed transmission service prices is to allocate the *AARR* to each category of prescribed transmission service in accordance with the *attributable cost share* for that category of services.

This allocation results in the *annual service revenue requirement (ASRR)* for that category of service.

Assuming an *AARR* of \$2,504,434 and applying the attributable cost shares determined above the *ASRR* for each category of prescribed services is calculated as:

$$\begin{aligned}
 ASRR_{\text{EXIT}} &= AARR \times \text{Attributable cost share}_{\text{EXIT}} \\
 &= \$2,504,434 \times 0.162 \\
 &= \$405,609
 \end{aligned}$$

with the *ASRRs* of the other categories calculated in the same manner.

Table 3 Annual Service Revenue Requirements

Category	Attributable cost share	Annual Service Revenue Requirement (ASRR)
Exit service	0.162	405,609
Entry service	0.041	102,453
TUOS service	0.780	1,952,741
Common Service	0.017	43,631
Total	1.000	2,504,434

6.8 Allocation of the ASRR to transmission network connection points

The fourth step in calculating prescribed transmission service prices is to allocate the ASRR for *prescribed entry services*, *prescribed exit services* and *prescribed TUOS services* to each transmission network connection point in accordance with the principles of clause 6A.23.3 of the Rules.

6.8.1 Prescribed entry services

The whole of the ASRR for *prescribed entry services* is allocated to each transmission network connection point in accordance with the *attributable connection point cost share* for *prescribed entry services* that are provided by the TNSP at that connection point.

The *attributable connection point cost share* for *prescribed entry services* is the ratio of the costs of the *transmission system assets directly attributable* to the provision of *prescribed entry services* at that transmission network connection point to the total costs of all the TNSP's *transmission system assets directly attributable* to the provision of *prescribed entry services*.

For example, if two generators, Gen A1 and Gen A2 receive *prescribed entry services* and the cost allocation process has allocated the ORCs of assets *directly attributable* to *prescribed entry services* to them as shown in Table 4.

$$\begin{aligned} \text{Attributable connection point cost share}_{\text{GEN A1}} &= \text{ORC}_{\text{GEN A1}} / \text{ORC}_{\text{ENTRY}} \\ &= \$1,033,333 / \$1,761,111 \\ &= 0.587 \end{aligned}$$

with the *attributable connection point cost share* of the other generator being calculated in the same manner as shown in Table 5.

Table 4: Prescribed entry services ORCs

Entry	ORC
Gen A1	1,033,333
Gen A2	727,778
Total ORC of prescribed entry assets	1,761,111

Table 5: Attributable connection point cost shares

Entry	ORC	Attributable connection point cost share
Gen A1	1,033,333	0.587
Gen A2	727,778	0.413
Total	1,761,111	1.000

The *ASRR* allocated to the Gen A1 transmission network connection point is calculated as follows:

$$\begin{aligned}
 ASRR_{\text{GEN A1}} &= ASRR_{\text{ENTRY}} \times \text{Attributable connection point cost share}_{\text{GEN A1}} \\
 &= \$102,453 \times 0.587 \\
 &= \$60,114
 \end{aligned}$$

with the *ASRR* of the other generator connection point being calculated in the same manner.

Table 6: Connection point *ASRRs* (entry)

Entry	ORC	Attributable connection point cost share	Connection point <i>ASRR</i>
Gen A1	1,033,333	0.587	60,114
Gen A2	727,778	0.413	42,338
Total	1,761,111	1.000	102,453

6.8.2 *Prescribed exit services*

The whole of the *ASRR* for *prescribed exit services* is allocated to each transmission network connection point in accordance with the *attributable connection point cost share* for *prescribed exit services* that are provided by the TNSP at that connection point.

The attributable connection point cost share for *prescribed exit services* is the ratio of the costs of the *transmission system assets directly attributable* to the provision of *prescribed exit services* at that transmission network connection point to the total costs of all the *transmission system assets directly attributable* to the provision of *prescribed exit services*.

The *ASRRs* of the prescribed exit connection points are calculated in the same manner as for the entry connection points.

Table 7: Connection point *ASRRs* (exit)

Exit	ORC	Attributable connection point cost share	Connection point <i>ASRR</i>
Load A1	2,083,333	0.299	121,198
Load A2	1,405,556	0.202	81,768
Load B1	2,633,333	0.378	153,194
Load C1	850,000	0.122	49,449
Total	6,972,222	1.000	405,609

6.8.3 Prescribed Transmission Use of System (TUOS) services

The prescribed TUOS (shared network) services ASRR is recovered from:

- *Prescribed TUOS services* (locational component); and
- *Prescribed TUOS services* (the adjusted non-locational component).

Clause 6A.23.3(c)(1) of the Rules requires that:

“a share of the ASRR (the locational component) is to be adjusted by subtracting the estimated *auction amounts* expected to be distributed to the TNSP under clause 3.18.4 from the *connection points* for each relevant *directional interconnector* and this adjusted share is to be allocated as between such *connection points* on the basis of the estimated proportionate use of the relevant *transmission system* assets by each of those customers, and the *CRNP methodology* and *modified CRNP methodology* represent two permitted means of estimating proportionate use”.

Consistent with clause 6A.23.3(c)(1) of the Rules, the locational share of the *prescribed TUOS services ASRR* is adjusted for estimated inter-regional settlements residue proceeds by converting the estimated proceeds to an equivalent asset replacement cost that is offset against the asset replacement cost of the relevant interconnector network pricing branches for input to the *cost reflective network pricing methodology (CRNP methodology)*⁴.

The adjusted share of the ASRR is allocated between connection points on the basis of the estimated proportionate use of the relevant *transmission system* assets by each customer using the *CRNP methodology*.

TransGrid proposes to continue applying the *CRNP methodology*.

The *CRNP methodology* allocates a proportion of shared network costs to individual customer connection points. TransGrid applies the *CRNP methodology* using the TPRICE *cost reflective network pricing* software used by most TNSPs in the NEM.

The *CRNP methodology* requires three sets of input data:

- An electrical (load flow) model of the network;
- A cost model of the network; and
- An appropriate set of load/ generation patterns.

Appendix BB describes the *CRNP methodology* in more detail.

The remainder of the ASRR (the pre-adjusted non-locational component) is to be adjusted:

- by subtracting the amount (if any) referred to in clause 6A.23.3(e) of the Rules;

⁴ In this way estimated settlements residue auction proceeds recover a portion of the ASRR allocated to shared network costs on a locational basis.

- by subtracting or adding any remaining settlements residue (not being settlements residue referred to in the determination of the locational component but including the portion of settlements residue due to intra-regional loss factors) which is expected to be distributed or recovered (as the case may be) to or from the TNSP in accordance with clause 3.6.5(a) of the Rules
- for any *over-recovery amount* or *under-recovery amount* from previous years;
- for any amount arising as a result of the application of clause 6A.23.4(h) and (i) of the Rules; and
- for any amount arising as a result of the application of prudent discounts in accordance with clause 6A.26.1(d)-(g) of the Rules,

6.8.4 Load and generation data

As noted in Appendix BB, the choice of operating conditions is important in developing prices using the *CRNP methodology*. TransGrid has flexibility in the choice of operating conditions, but notes that the old Rules set out the principles that should apply in determining the sample of operating conditions considered. Of particular note is the requirement that operating conditions to be used are to include at least 10 days with high system demand, to ensure that loading conditions, which impose peak flows on all transmission elements, are captured.

Schedule 6A.3.2(3) of the Rules is less prescriptive requiring that the allocation of dispatched generation to loads be over a range of actual operating conditions from the previous financial year and that the range of operating scenarios be chosen so as to include the conditions that result in most stress on the transmission network and for which network investment may be contemplated.

Clause 2.2(a) of the *pricing methodology guidelines* requires that prices for the recovery of the locational component of *prescribed TUOS services* are based on demand at times of greatest utilisation of the transmission network and for which network investment is most likely to be contemplated in accordance with clause 6A.23.4(e) of the Rules.

The use made of the network by particular loads and generators will vary considerably depending on the load and generation conditions on the network. For this reason a number of operating scenarios are examined with different load and generation patterns.

In selecting those operating scenarios it is important to recognise that the operating conditions that impose most stress on particular network elements may occur at times other than for system peak demand.

The TPRICE method of cost allocation (used by TransGrid) automatically captures the peak loading conditions on network elements from the sample of operating conditions analysed.

TransGrid, therefore, uses the full year of operating data (i.e. 365 days of half hourly data) to avoid the need for judgement concerning an appropriate set of operating conditions.

Consistent with clause 2.2(f) of the *pricing methodology guidelines* where actual operating conditions from the previous complete financial year are unavailable for a connection point, as would be the case for a new connection point, or material changes in customer requirements at a connection point, an estimate of demand must be used instead. TransGrid has previously derived this estimate from information obtained from the relevant transmission network customer via the connection application and connection amendment processes set out in Chapter 5 of the National Electricity Rules. These Rules impose sufficient obligations on transmission network customers, and intending transmission network customers, to ensure sufficient integrity of this data in advance of actual operating conditions can be recorded. TransGrid intends to continue its past practice in this regard.

6.8.5 Network support costs

An estimate of network support costs is converted to an equivalent asset replacement cost that is added to the asset replacement cost of the transmission assets these services support.

TransGrid will recover these costs on a locational basis as part of its *CRNP methodology*.

Recovery of network support costs on a locational basis is appropriate given that the alternative network augmentation costs would be recovered on this basis.

6.9 Transmission prices and charges

6.9.1 Prescribed entry and exit services prices

Prescribed entry services and *prescribed exit services* prices are calculated to recover the *prescribed entry and prescribed exit services ASRRs* from the network users who are served by the relevant connection assets.

The *prescribed entry services ASRR* is recovered as a fixed annual charge for each entry point, which is recovered on the basis of a fixed \$/day entry price.

Similarly, the *prescribed exit services ASRR* is recovered as a fixed annual charge for each exit point, which is recovered on the basis of a fixed \$/day exit price.

6.9.2 Prescribed TUOS services – locational component prices and charges

TransGrid's future locational component of its charges and prices will be determined on the basis of a maximum monthly demand charge.

The CRNP methodology outlined in S6A.3 of the Rules describes the process for cost allocation for the locational component of *prescribed TUOS services*, which results in a lump sum dollar amount to be recovered at each connection point as described in Appendix B.

To calculate rates, TransGrid adopts the level and pattern of usage is the same as in the previous financial year. Specifically the maximum demand charge at each connection point is calculated by dividing the amount by the average of the monthly maximum demands in each month at that connection point in the previous financial year (with adjustment for forecast system load growth from the historical period to the

period during which the prices will apply) and express the result as a rate in \$/kW/month.

Where there are both customer loads and generator auxiliary loads at a connection point, rates are set on the basis of the full load at the point, even though the generator does not pay usage charges.

Multiple Supply Points to a Particular Load

In some cases, there is a back up supply to a particular load (e.g. a town or large industrial customer) and simple application of the pricing calculation could give very different prices for the two connections. Where it is assessed that this may create incentives to the customer to switch supply points, and that this would not be consistent with efficient operation of the network, the variable rates at the two points may be set to the same levels and a fixed charge used to obtain the balance of usage revenue allocated to the point.

As provided for under clause 6A.23.4(f) of the Rules TUOS locational prices must not change by more than 2% per annum at connection points relative to the load weighted average TUOS locational price for the region. The balance of any revenue shortfall, or over recovery resulting from these price caps, is recovered or offset, as appropriate, by adjusting TUOS non-locational prices and charges.

As further provided for under clause 6A.23.4(g) of the Rules the change specified above “may exceed 2 per cent per annum if, since the last prices were set:

- (1) the *load* at the *connection point* has materially changed;
- (2) in connection with that change, the *Transmission Customer* requested a renegotiation of its *connection agreement* with the *Transmission Network Service Provider*; and
- (3) the AER has approved the change of more than 2 per cent per annum.”

The effect of this provision is to set the prescribed TUOS – locational price at a connection point with a material change in load on the same basis as a new connection point.

In the event that a Transmission Customer requests a material change in *agreed maximum demand* at an existing connection point, TransGrid will seek approval from the AER to set the prescribed TUOS – locational price as intended by clause 6A.23.4(g) of the Rules.

Any over or under recovery of prescribed revenue arising from variances between actual demand and the demand used for calculating charges, will be addressed by way of an under or over recovery adjustment when calculating prices for the following financial year.

6.9.3 Prescribed TUOS services – non-locational component prices and charges

Prices for recovery of the adjusted non-locational component of *prescribed TUOS services* will be set on a postage stamp basis in accordance with clause 6A.23.4(j) of the Rules.

Consistent with the provisions of clause 2.3(c)(1) of the *pricing methodology guidelines* postage stamped prices will be determined on the basis of *contract agreed maximum demand* or historical energy and calculated annually as follows.

Each financial year TransGrid will determine the following two prices:

- An energy based price that is a price per unit of historical metered energy or current metered energy at a connection point expressed as c/kWh; and
- a *contract agreed maximum demand* price that is a price per unit of *contract agreed maximum demand* at a connection point expressed as \$/kW/month.

Either the energy based price, or the *contract agreed maximum demand* price, will apply at a connection point providing *prescribed TUOS services* except for those connection points where a transmission customer has negotiated reduced charges for adjusted non-locational component of *prescribed TUOS services* in accordance with clause 6A.26.1 of the Rules.

The energy based price and the *contract agreed maximum demand* price will be determined so that:

- a transmission customer with a load factor in relation to its connection point equal to the median load factor for connection points with transmission customers connected to the transmission network in the region or regions is indifferent between the use of the energy based price and the *contract agreed maximum demand* price; and
- the total amount to be recovered by the adjusted non-locational component of *prescribed TUOS services* does not exceed the *ASRR* for this category of prescribed transmission service.

When applying the energy based price, the prescribed TUOS – non-locational component charge for a billing period will be calculated for each connection point by:

- multiplying the energy based price by the metered energy off-take at that connection point in the corresponding billing period two years earlier (i.e. *historical metered energy off-take*); or
- multiplying the energy based price by the metered energy off-take at that connection point in the same billing period (*current metered energy off-take*) if the *historical metered energy off-take* is unavailable; or
- multiplying the energy based price by the *current metered energy off-take* if the *historical metered energy off-take* is significantly different to the current metered energy off-take. This method of calculation is only expected to be applied where the conditions necessary to enact clause 6A.23.4(g)⁵ of the Rules have been satisfied,

When applying the *contract agreed maximum demand* price, the prescribed TUOS – non-locational component charge for a billing period will be calculated for each

⁵ That being the clause which allows for the relaxation of the side constraints on TUOS locational prices at a connection point.

connection point by multiplying the *contract agreed maximum demand* price by the *contract agreed maximum demand* for the *connection point* (prevailing during the billing period concerned and expressed in \$/kW/month) and multiplying this amount by the number of months in the billing period.

The energy based price or the *contract agreed maximum demand* price that applies for the adjusted non-locational component of *prescribed TUOS services* at a connection point will generally be the one which results in the lower estimated charge for that prescribed transmission service. However, if the customer has elected not to use the *contract agreed maximum demand* price option, or has not entered into an agreement with TransGrid which specifies the level of the *contract agreed maximum demand*, then the energy based price shall apply.

6.10 Prescribed common service prices and charges

Prices for *prescribed common transmission services* will be set on a postage stamp basis in accordance with clause 6A.23.4(d) of the Rules.

Consistent with the provisions of clause 2.3(c)(1) of the *pricing methodology guidelines* postage stamped prices will be determined on the basis of *contract agreed maximum demand* or historical energy and calculated in a manner identical to that described for TUOS non-locational charges in the previous section.

In accordance with clause 6A.23.3(f) of the Rules the operating and maintenance costs expected to be incurred in the provision of *prescribed common transmission services*, which are deducted from the *maximum allowed revenue* to form the *AARR*, are added to the *ASRR* for *prescribed common transmission services* and recovered through *prescribed common service prices and charges*.

6.11 Excess demand charge

For those customers who have chosen to have their general and common service charges set on the basis of *contract agreed maximum demand*, TransGrid needs to calculate an excess demand charge that will apply if the nominated demand is exceeded. The rate to be used in calculating the excess demand charge is set out in formal agreements with the customer, preferably in the relevant connection agreement, and therefore may be different for different customers.

To date, only two customers have taken up this option and the excess demand charge rate is identical. The calculation requires as input: the revenue cap for the coming year and TransGrid's reasonable estimate of maximum demand in that year. The demand estimate is obtained from forecasts prepared for the Annual Planning Report and for NEMMCO's Statement of Opportunities. The figure used is the 50% probability of exceedence under the medium growth scenario. At present this is the winter demand figure for the first calendar year of the financial year period (e.g., winter 2009 for 2009-10).

Once the rate has been calculated the relevant customers will be advised by email or letter before 1 July each year.

6.12 Setting of TUOS locational prices between annual price publications

In the event that TransGrid is required to set a TUOS locational price at a new connection point or at a connection point where the load has changed significantly⁶ after prescribed TUOS service locational prices have been determined and published, an interim price, not subject to the side constraints of clause 6A.23.4(f) of the Rules, will be determined. This will be calculated using the prevailing pricing models and soundly based forecasts of peak demand. Suitable adjustments to reflect actual outcomes that differ from forecasts will be negotiated with the customer for inclusion in the relevant connection agreement.

A price subject to the side constraints of clause 6A.23.4(f) of the Rules will be determined and published at the next annual price determination.

7. Billing Arrangements

7.1 Billing for prescribed transmission services

Consistent with clause 6A.27.1 of the Rules, TransGrid will calculate the transmission service charges payable by *Transmission Network Users* for each connection point in accordance with the transmission service prices published under clause 6A.24.2.

Where charges are determined for *prescribed transmission services* from metering data, these charges will be based on kW or kWh obtained from the metering data managed by NEMMCO.

TransGrid will issue bills to *Transmission Network Users* for *prescribed transmission services* which satisfy or exceed the minimum information requirements specified in clause 6A.27.2 of the Rules on a monthly basis or as specified in the transmission connection agreement.

Consistent with clause 6A.27.3 of the Rules a *Transmission Network User* must pay charges for *prescribed transmission services* properly charged to it and billed in accordance with this *pricing methodology* by the date specified on the bill.

7.2 Payments between Transmission Network Service Providers

Consistent with clause 6A.27.4 of the Rules, where TransGrid is the *Co-ordinating Network Service Provider* under clause 6A.29.1 of the Rules, it will pay to each other relevant *Transmission Network Service Provider* the revenue which is estimated to be collected during the following year by the first provider as charges for *prescribed transmission services* for the use of transmission systems owned by those other *Transmission Network Service Providers*.

Such payments will be determined by TransGrid as the *Co-ordinating Network Service Provider* for the region.

Financial transfers payable under clause 6A.27.4 of the Rules will be paid in equal monthly instalments or as documented in revenue collection agreements negotiated between the parties.

⁶ For an existing connection point this would be subject to clause 6A.23.4(g) of the Rules.

8. Prudential Requirements

8.1 Prudential requirements for prescribed transmission services

Consistent with clause 6A.28.1 of the Rules, TransGrid may require a *Transmission Network User* to establish prudential requirements for either or both connection services and transmission use of system services. These prudential requirements may take the form of, but need not be limited to, capital contributions, pre-payments or financial guarantees.

The requirements for such prudential requirements will be negotiated between the parties and specified in the applicable transmission connection agreement.

8.2 Capital contribution or prepayment for a specific asset

Consistent with clause 6A.28.2 of the Rules, where TransGrid is required to construct or acquire specific assets to provide prescribed connection services or *prescribed TUOS services* to a *Transmission Network User*, TransGrid may require that user to make a capital contribution or prepayment for all or part of the cost of the new assets installed.

TransGrid notes that no capital contributions or prepayments have been made in respect of prescribed transmission services assets as at the date of this proposed *pricing methodology*.

In the event that a capital contribution is required any contribution made will be taken into account in the determination of prescribed transmission service prices applicable to that user by way of a proportionate reduction in the ORC of the asset(s) used for the allocation of prescribed charges or as negotiated between the parties.

In the event that a prepayment is required any prepayment made will be taken into account in the determination of prescribed transmission service prices applicable to that user in a manner to be negotiated between the parties.

The treatment of such capital contributions or prepayments for the purposes of a revenue determination will in all cases be in accordance with the relevant provisions of the Rules.

9. Giving Effect to National Electricity Rules Pricing Principles

This proposed *pricing methodology* is consistent with the requirements of the AER's Pricing Methodology Guidelines, supported by proposed compliance arrangements as set out in Section 11 of this proposed *pricing methodology*. As such this methodology, once approved by the AER, should give effect to, and be consistent with, the pricing principles for prescribed transmission services.

10. Prudent Discounts

TransGrid has a very small number of its customers currently receiving prudent discounts. These arrangements have been subject to the existing approval processes, involving either the ACCC or the AER, as required by the old Rules. At

the time of drafting this proposed *pricing methodology* TransGrid was not aware of any new applications for a prudent discount under Clause 6A.26.2 of the current Rules.

In accordance with rule 6A.26.1(d)-(g), recovery of the current, and any future, prudent discounts, approved by the AER in accordance with Clause 6A.26.2 of the current Rules, would be to adjust the non-locational component of the *ASRR* for *prescribed TUOS services* for the amount of any anticipated under-recovery arising from prudent discounts applied.

11. Monitoring and Compliance

As a regulated business TransGrid is required to maintain extensive compliance monitoring and reporting systems to ensure compliance with its State Owned Corporations Act, National Electricity Law, and the Rules, together with numerous other legislative obligations.

In order to monitor and maintain records of its compliance with its approved *pricing methodology*, the pricing principles for *prescribed transmission services*, and part J of the Rules, TransGrid proposes to:

- Maintain the specific obligations arising from part J of the Rules in its compliance management system;
- Maintain electronic records of the annual calculation of prescribed transmission service prices and supporting information; and
- Periodically subject its transmission pricing models and processes to functional audit by suitably qualified persons.

12. Description of Pricing Methodology Differences

TransGrid's existing pricing methodology complies fully with the old Rules and essentially meets the requirements of the current Chapter 6A of the new Rules. This methodology is set out in detail in internal TransGrid Procedures and is largely the same as described in this proposed *pricing methodology*, including its implementation and a number of hypothetical worked examples. The remainder of this section outlines the main differences between the existing and proposed pricing methodologies.

12.1 Removal of Peak and Shoulder Average Demand Rates from Locational Charges

TrnsGrid's existing pricing methodology recovers the locational component of TUOS via two forms of demand charge. Half the locational charge is recovered via a rate applied to the average demand occurring over the peak and shoulder demand periods (7 AM to 10 PM on working week days) in each month. The other half of the locational charge is recovered via a maximum demand charge at each connection point multiplied by the maximum half hourly average demand to occur in that month.

Under the proposed *pricing methodology* all of the locational charge will be recovered via a maximum demand charge at each connection point multiplied by the maximum half hourly average demand to occur in that month.

12.2 Costs that could be allocated to more than one category of service

Clause 6A.23.2(d) of the Rules introduced a priority ordering concept for the allocation of those costs which could be attributable to more than one category of *prescribed transmission services*.

The cost allocation process has been modified to allocate the substation local costs in accordance with the provisions of clause 6A.23.2(d) of the Rules having regard to the stand alone costs associated with the provision of *prescribed TUOS services* and *prescribed common transmission services* with the remainder being allocated to *prescribed entry and prescribed exit services*. This cost allocation process is described in detail in Appendix C.

This modification will result in relatively minor reallocations of charges between the categories of transmission services. TransGrid does not expect that the changes to prices resulting from this modification will be material.

12.3 Provision for relaxation of TUOS locational side constraints

The implementation of clause 6A.23.4(g) of the Rules allows for the relaxation of the 2% side constraint for material changes in connection point load or renegotiation of connection agreements, subject to AER approval. This matter has already been addressed in Section 6.9.2 of this proposed *pricing methodology*.

13. Additional information requirements

A number of additional information requirements arise from the *pricing methodology guidelines* which have not been covered elsewhere in this proposed *pricing methodology*. In order to satisfy these requirements TransGrid notes that it does not consider transitional arrangements are necessary as a result of the implementation of the proposed *pricing methodology* including that the status quo in respect of 'carry overs' should not be affected by the transition to Chapter 6A.

TransGrid also notes that, apart from provisions contained in *Power Supply Agreements* (as defined in Chapter 9 of the National Electricity Rules) Chapter 9 derogations do not impact on the arrangements in this proposed *pricing methodology*. In accordance with the Rules, the requirements of these *Power Supply Agreements* take precedence over the requirements of the Rules to the extent that they might address transmission pricing requirements.

TransGrid has not provided a confidential version of this proposed *pricing methodology* to the AER in accordance with clause 2.5 of the *pricing methodology guidelines* and hence the provisions of clause 2.1(n) of the *pricing methodology guidelines* are not applicable.

14. Conclusion

TransGrid's proposed *pricing methodology* for the regulatory control period from 1 July 2009 to 30 June 2014 has been submitted to the AER in accordance with the requirements of Chapter 6A of the Rules and the *pricing methodology guidelines*.

TransGrid is confident that its proposed *pricing methodology* fully satisfies the requirements of the Rules and the *pricing methodology guidelines*.

Appendix A - Structure of Transmission Pricing under Part J of Rules

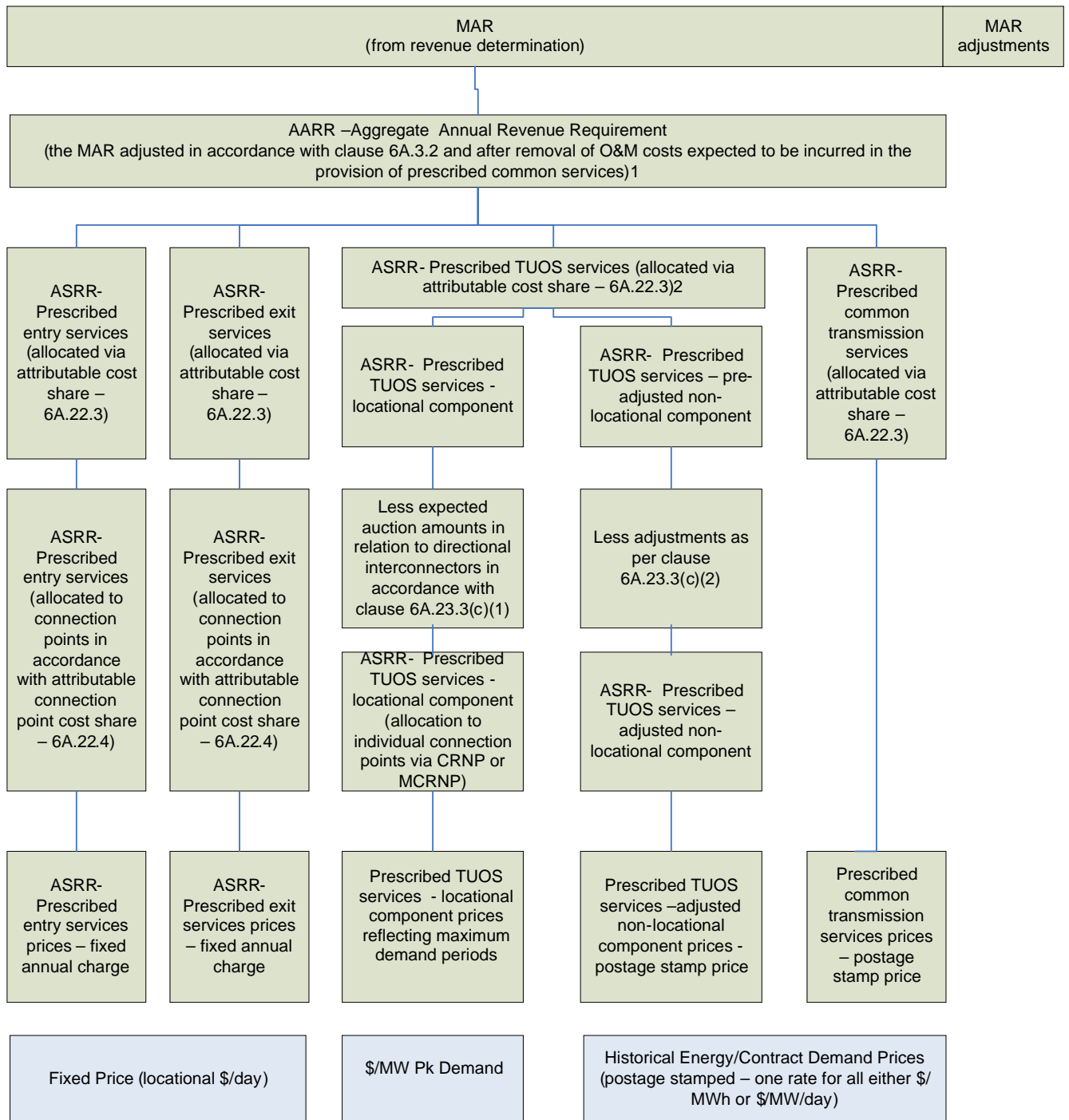

¹ These operating and maintenance costs are not part of the AARR, nor are they part of the ASRR for prescribed common transmission services, however they are recovered on a postage stamp basis.

² Shares of the ASRR for prescribed TUOS services are to be allocated 50% to the locational component and 50% to the pre-adjusted non-location component or using an alternative allocation as per clause 6A.23.3(d)(2).

Appendix B - Cost Reflective Network Pricing Methodology

The *cost reflective network pricing methodology (CRNP methodology)* generally involves the following steps:

- (1) Determining the annual costs of the individual transmission network assets in the optimised transmission network;
- (2) For modified CRNP, adjusting each asset's cost according to its expected utilisation;
- (3) Determining the proportion of each individual network element utilised in providing a transmission service to each point in the network for specified operating conditions.
- (4) Determining the maximum flow imposed on each transmission element by load at each connection point over a set of operating conditions.
- (5) Allocating the costs attributed to the individual transmission elements to loads based on the proportionate use of the elements.
- (6) Determining the total cost (lump sum) allocated to each point by adding the share of the costs of each individual network attributed to each point in the network.

Allocation of Generation to Load

A major assumption in the use of the *CRNP methodology* is the definition of the generation source and the point where load is taken. The approach is to use the "electrical distance" to pair generation to load, in which a greater proportion of load at a particular location is supplied by generators that are electrically closer than those that are electrically remote. In electrical engineering terminology the "electrical distance" is the impedance between the two locations, and this can readily be determined through a standard engineering calculation called the "fault level calculation".

Once the assumption has been made as to the generators that are supplying each load for a particular load and generation condition (time of day) it is possible to trace the flow through the network that results from supplying each load (or generator). The use made of any element by a particular load is then simply the ratio of the flow on the element resulting from the supply to this load to the total use of the load made by all loads and generators in the system.

Operating Conditions for Cost Allocation

The choice of operating conditions is important in developing prices using the *CRNP methodology* or *modified CRNP methodology*. TransGrid has flexibility in the choice of operating conditions but notes that the old NER set out the principles that should apply in determining the sample of operating conditions considered. Of particular note is the requirement that the operating conditions to be used are to include at least 10 days with high system demand, to ensure that loading conditions, which impose peak flows on all transmission elements, are captured.

Schedule 6A.3.2(3) is less prescriptive requiring that the allocation of dispatched generation to loads be over a range of actual operating conditions from the previous financial year and that the range of operating scenarios is chosen so as to include the conditions that result in

most stress on the transmission network and for which network investment may be contemplated.

The use made of the network by particular loads and generators will vary considerably depending on the load and generation conditions on the network. For this reason a number of operating scenarios are examined with different load and generation patterns.

In selecting those operating scenarios it is important to recognise that the operating conditions that impose most stress on particular elements may occur at times other than for system peak demand.

Appendix C - Priority Ordering Methodology

Rules Requirement

Clause 6A.23.2(d) of the Rules requires that:

Where, as a result of the application of the *attributable cost share*, a portion of the *AARR* would be attributable to more than one category of *prescribed transmission services*, that *attributable cost share* is to be adjusted and applied such that any costs of a *transmission system* asset that would otherwise be attributed to the provision of more than one category of *prescribed transmission services*, is allocated as follows:

- (1) to the provision of *prescribed TUOS services*, but only to the extent of the *stand-alone amount* for that *category of prescribed transmission services*;
- (2) if any portion of the costs of a *transmission system* asset is not allocated to *prescribed TUOS services*, under subparagraph (1), that portion is to be allocated to *prescribed common transmission services*, but only to the extent of the *stand-alone amount* for that *category of prescribed transmission services*;
- (3) if any portion of the costs of a *transmission system* asset is not attributed to *prescribed transmission services* under subparagraphs (1) and (2), that portion is to be attributed to *prescribed entry services* and *prescribed exit services*.

Stand-alone amount is defined as:

For a *category of prescribed transmission services*, the costs of a *transmission system* asset that would have been incurred had that *transmission system* asset been developed, exclusively to provide that *category of prescribed transmission services*.

AEMC Rule determination

In its rule determination the AEMC provided the following guidance on the application of the priority ordering approach for the allocation of costs which can be attributed to more than one type of service⁷:

“The Commission has maintained a priority ordering approach for the allocation of expenses or costs which can be attributed to more than one type of service. The cascading principle adopted by the Commission is based on the premise that users are seen to be the ‘cause’ of transmission investment. Therefore, costs should be first allocated to prescribed transmission use of system services on a stand-alone basis and then to *prescribed common transmission services*. Where a service/cost cannot justifiably be attributed to TUOS or common services it should be allocated to entry and exist services.”

In developing this methodology TransGrid has had regard for the following example in the rule determination⁸:

Consider a substation costing \$30 million that was developed:

⁷ Rule Determination for National Electricity Amendment (Pricing of *Prescribed Transmission Services*) Rule 2006 p5

⁸ Ibid p37

- partly in order to provide *Prescribed TUOS services*;
- partly in order to provide *Prescribed common transmission services*; and
- partly in order to provide *prescribed exit services*.

Then assume that had the substation been developed solely to provide *prescribed TUOS services*, it could have been much smaller and would have cost only \$10 million. Had the substation been developed solely in order to provide *prescribed common transmission services*, it would have cost \$5 million. Finally, had the substation been developed solely in order to provide *prescribed exit services*, it would have cost \$20 million.

The application of the principle would then lead to the \$30 million cost of the substation being attributed to Prescribed Transmission Service categories as follows:

- \$10m to the *prescribed TUOS services ASRR*;
- \$5m to the *prescribed common services ASRR*; and
- the remaining \$15 million to the *prescribed exit service ASRR*.

Objective and General Approach

The proposed allocation methodology relies on the assumption that substation infrastructure and establishment costs are proportionate to the number of high voltage circuit breakers in the substation.

Based on this assumption the appropriate allocator for substation infrastructure and establishment costs for a stand-alone arrangement is the ratio of the number of high voltage circuit breakers⁹ in the stand-alone arrangement to the number of high voltage circuit breakers in the whole substation.

Proposed Methodology

Step 1: Branch Identification

Identify the branches¹⁰, being the lines, transformers, major reactive devices and exits/entries in the substation which provide *prescribed TUOS*, *prescribed common transmission services* and exit or entry services, in the substation.

Step 2: Allocation of Circuit Breakers to Branches

For each high voltage circuit breaker in the substation identify the branches directly connected to it. Any circuit breaker that does not directly connect to a branch is excluded from allocation and all costs associated with it are added to the substation infrastructure and establishment cost.

Count the total number of circuit breakers directly connected to branches.

As a general rule, Distribution Network Service Providers (DNSPs) are classified as a *prescribed exit service* while Generators are classified as a *prescribed entry service*.

⁹ Low voltage circuit breakers are not considered in the standalone arrangements.

¹⁰ Described in TDefinition - Branches.

Negotiated services are not part of the regulated asset base and fall outside the priority ordering process detailed in clause 6A.23.2(d) of the Rules.

Step 3.1: Stand-alone arrangements for Prescribed TUOS

With reference to the number of lines providing *prescribed TUOS services* determine the number of circuit breakers required to provide TUOS services of an equivalent standard on a stand-alone basis¹¹. The stand-alone configuration is the simplest substation configuration (in the absence of development) had it been developed to provide a prescribed TUOS service. This may be done by way of a look up of typical stand-alone configurations.

Step 3.2: Stand-alone arrangements for Prescribed common transmission services

With reference to the number of lines providing *prescribed TUOS services* and the devices providing *prescribed common service* determine the number of circuit breakers required to provide *prescribed common transmission services* of an equivalent standard on a stand-alone basis. The stand-alone configuration is the simplest substation configuration (in the absence of development) had it been developed to provide a *prescribed common service*. This may be done by way of a look up of typical stand-alone configurations.

Step 4: Allocation of substation infrastructure and establishment costs

Step 4.1. Allocation of Prescribed TUOS

Allocate a portion of substation infrastructure and establishment costs to prescribed TUOS according to the ratio of the high voltage circuit breakers identified in step 3.1 to the total number of high voltage circuit breakers connected to branches in the substation identified in step 2.

Step 4.2 Calculate the Unallocated Substation Infrastructure Costs after TUOS Allocation

Calculate the Unallocated substation infrastructure cost by subtracting the amount calculated in step 4.1 from the total substation infrastructure amount.

Step 4.3 Allocation of Prescribed Common Service

Allocate a portion of the substation infrastructure and establishment costs to *prescribed common service* based on to the ratio of the high voltage circuit breakers providing *prescribed common transmission services* identified in step 3.2 to the total number of high voltage circuit breakers connected to branches in the substation. If the common service portion of substation infrastructure is greater than the Unallocated costs, then the Unallocated portion only is attributed to *prescribed common service*. In this instance, nothing will be attributed to *prescribed entry and prescribed exit services*.

Step 4.4 Calculate the Unallocated Substation Infrastructure Costs after Common Service Allocation

Calculate the Unallocated substation infrastructure cost by subtracting the amount calculated in step 4.3 from the amount calculated in step 4.2.

¹¹ Whilst an argument can be made that a substation would typically not exist to provide TUOS services alone it is believed that this is inconsistent with the intent of the rule. Accordingly standalone arrangements for prescribed TUOS are taken to require a level of switching consistent with the prevailing bus arrangements.

Step 4.5 Allocation of Prescribed Entry and Exit Service

Allocate the remaining substation infrastructure and establishment costs (calculated in step 4.4) to each branch providing prescribed exit or entry services based on the ratio of the high voltage circuit breakers providing the entry or exit service to the branch to the total number of high voltage circuit breakers providing entry or exit services or in accordance with the cost allocation process in **Error! Reference source not found.** as appropriate.

Notes

- Costs are only allocated in step 4 until fully allocated.
- Consistent with clause 6A.23.2(d)(3) of the Rules it is possible that no costs will be attributed to entry and exit services.
- New and existing negotiated service assets are excluded from the analysis as any incremental establishment costs associated with them are taken to be included in the negotiated services charges on a causation basis.
- The assessment of standalone arrangements only needs to be conducted once per substation except where changes to the configuration of the substation occur.

Definition - Branches

As illustrated by the diagrams below a “Branch” is a collection of assets (e.g. lines, circuit breakers, capacitors, buses and transformers) that provide a transmission service.

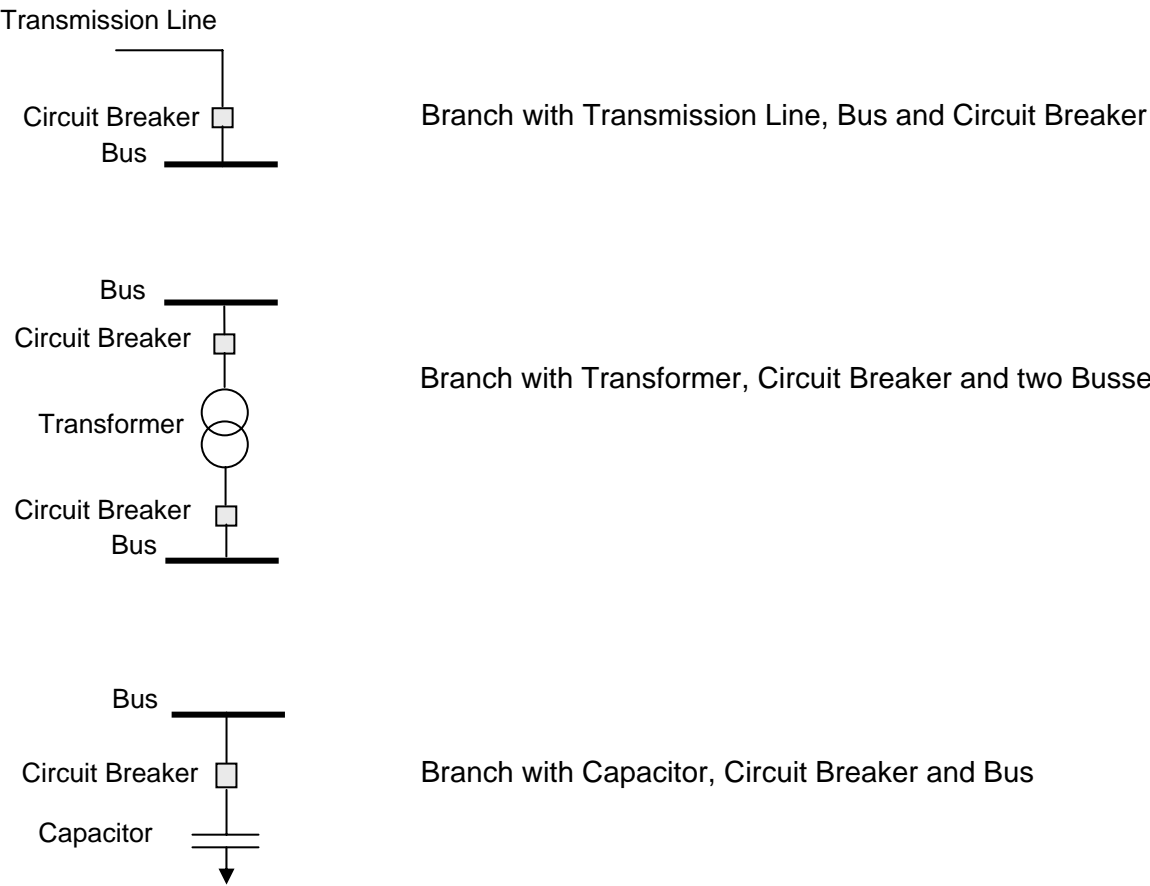

Examples

Example A

Substation Configuration

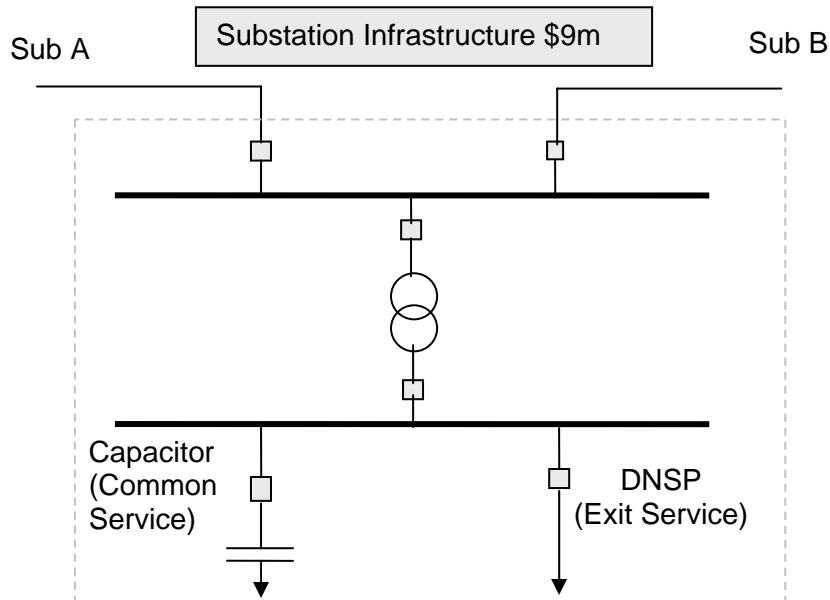

Step 1: The branches are Sub A, Sub B, DNSP, Tie Transformer and PCS.

Step 2: The total number of circuit breakers directly connected to branches is 6.

Step 3.1: The stand-alone arrangement for the provision of *prescribed TUOS services* to an equivalent standard is shown below and consists of 2 circuit breakers.

Stand Alone Prescribed TUOS Service



Step 3.2: The stand-alone arrangement for the provision of *prescribed common transmission services* to an equivalent standard is shown below and consists of 3 circuit breakers.

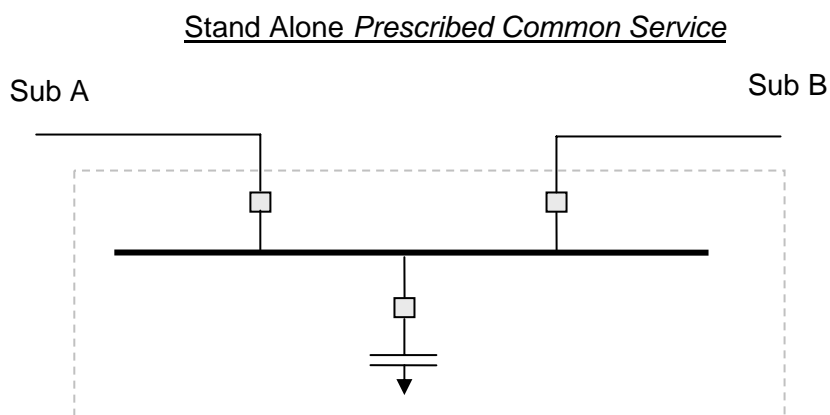

Step 4:

Assume total Infrastructure cost is \$9m.

Costs are allocated to prescribed TUOS in the ratio of the circuit breakers in the stand-alone arrangement to the total circuit breakers.

$$\text{Infrastructure Cost Allocated to TUOS} = (2/6) \times \$9\text{m} = \$3\text{m}$$

$$\text{Unallocated} = \$9\text{m} - \$3\text{m} = \$6\text{m}$$

Costs are allocated to *prescribed common service* in the ratio of the circuit breakers in the stand-alone arrangement to the total circuit breakers.

$$\text{Infrastructure Cost allocated to Common Service} = (3/6) \times \$9\text{m} = \$4.5\text{m}$$

$$\text{Unallocated} = \$6\text{m} - \$4.5\text{m} = \$1.5\text{m}$$

Remainder of Unallocated (calculated above) to be allocated to *prescribed entry and prescribed exit services*.

$$\text{Infrastructure Cost allocated to Exit} = \$1.5\text{m}$$

Item	Number	Allocation	Unallocated
Substation infrastructure costs		9,000,000	9,000,000
Total Breakers	6		
TUOS Stand-alone breakers	2		
Share to TUOS	0.333	3,000,000	6,000,000
Common Service stand-alone breakers	3		
Share to Common Service	0.500	4,500,000	1,500,000
Share to Entry and Exit services		1,500,000	

Example B

Substation Configuration

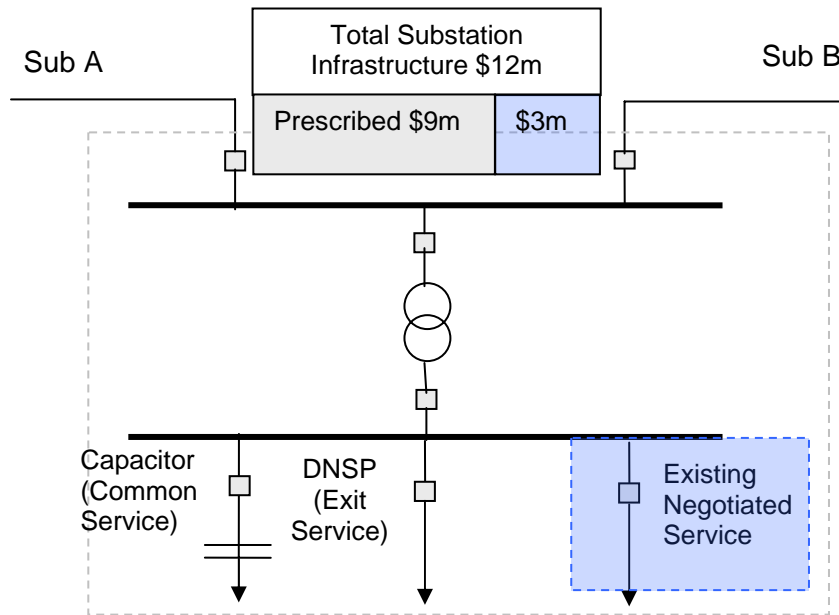

Step 1: The branches are Sub A, Sub B, DNSP, Tie Transformer, PCS and an existing negotiated service.

Step 2: The total number of circuit breakers directly connected to branches is 6 (no prescribed costs are allocated to the existing negotiated service).

Step 3.1: The stand-alone arrangement for the provision of *prescribed TUOS services* to an equivalent standard is shown below and consists of 2 circuit breakers.

Stand Alone Prescribed TUOS Service



Step 3.2: The stand-alone arrangement for the provision of *prescribed common transmission services* to an equivalent standard is shown below and consists of 3 circuit breakers.

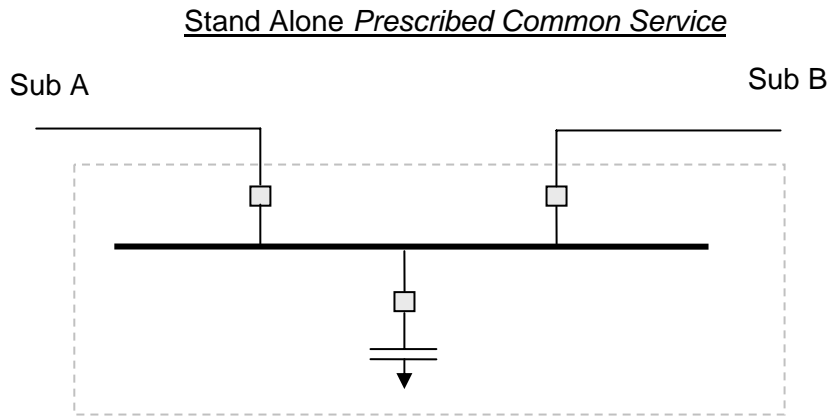

Step 4:

Assume total Infrastructure cost is \$12m, however \$3m is for the existing negotiated service, which does not form part of the regulated asset base and is not governed by 6A.23.2(d).

Costs are allocated to prescribed TUOS in the ratio of the circuit breakers in the stand-alone arrangement to the total circuit breakers.

$$\text{Infrastructure Cost Allocated to TUOS} = (2/6) \times \$9\text{m} = \$3\text{m}$$

$$\text{Unallocated} = \$9\text{m} - \$3\text{m} = \$6\text{m}$$

Costs are allocated to *prescribed common service* in the ratio of the circuit breakers in the stand-alone arrangement to the total circuit breakers.

$$\text{Infrastructure Cost allocated to Common Service} = (3/6) \times \$9\text{m} = \$4.5\text{m}$$

$$\text{Unallocated} = \$6\text{m} - \$4.5\text{m} = \$1.5\text{m}$$

Remainder of Unallocated (calculated above) to be allocated to *prescribed entry and prescribed exit services*.

$$\text{Infrastructure Cost allocated to Exit} = \$1.5\text{m}$$

Item	Number	Allocation	Unallocated
Substation infrastructure costs		9,000,000	9,000,000
Total Breakers	6		
TUOS Stand-alone breakers	2		
Share to TUOS	0.333	3,000,000	6,000,000
Common Service stand-alone breakers	3		
Share to Common Service	0.500	4,500,000	1,500,000
Share to Entry and Exit services		1,500,000	

Example C

Substation Configuration

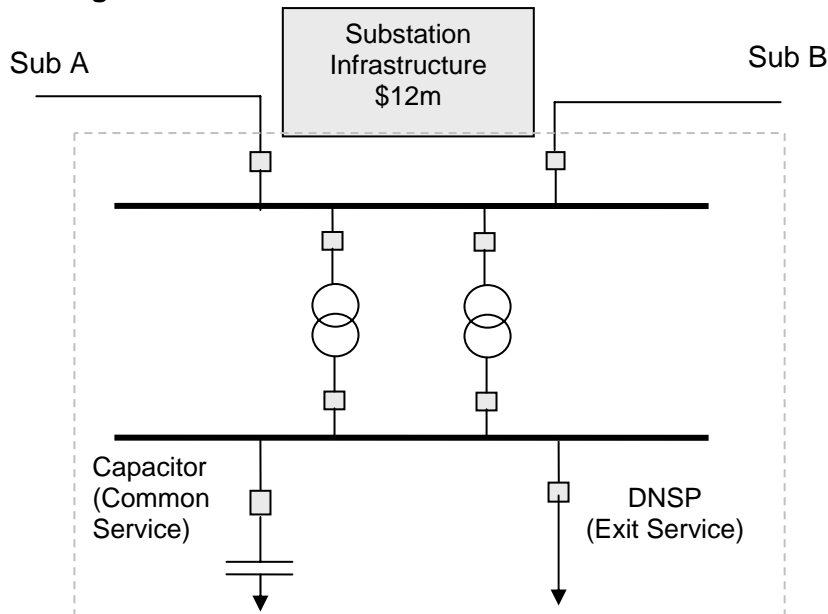

Step 1: The branches are Sub A, Sub B, DNSP, Tie Transformer 1, Tie Transformer 2 and PCS.

Step 2: The total number of circuit breakers directly connected to branches is 8.

Step 3.1: The stand-alone arrangement for the provision of *prescribed TUOS services* to an equivalent standard is shown below and consists of 2 circuit breakers.

Stand Alone Prescribed TUOS

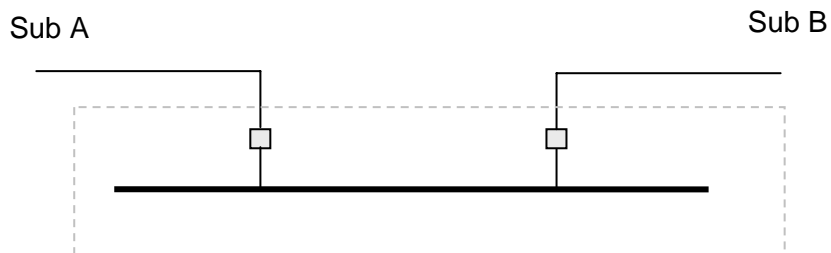

Step 3.2: The stand-alone arrangement for the provision of *prescribed common transmission services* to an equivalent standard is shown below and consists of 3 circuit breakers.

Stand Alone Prescribed Common Service

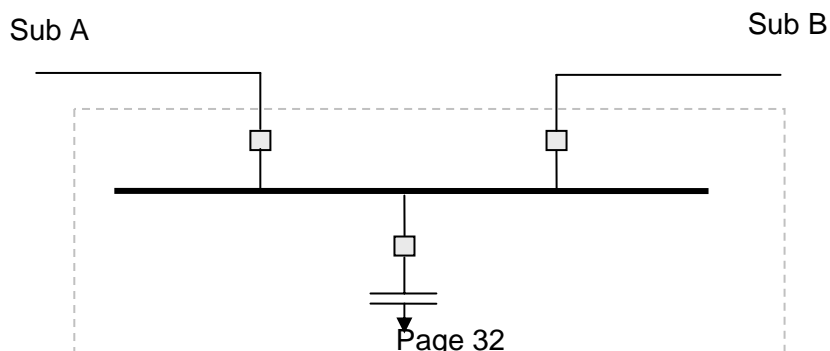



Step 4:

Assume total Infrastructure cost is \$12m.

Costs are allocated to prescribed TUOS in the ratio of the circuit breakers in the stand-alone arrangement to the total circuit breakers.

Infrastructure Cost Allocated to TUOS = $(2/8) \times \$12m = \$3m$

Unallocated = $\$12m - \$3m = \$9m$

Costs are allocated to *prescribed common service* in the ratio of the circuit breakers in the stand-alone arrangement to the total circuit breakers.

Infrastructure Cost allocated to Common Service = $(3/8) \times \$12m = \$4.5m$

Unallocated = $\$9m - \$4.5m = \$4.5m$

Remainder of Unallocated (calculated above) to be allocated to *prescribed entry and prescribed exit services*.

Infrastructure Cost allocated to Exit = $\$4.5m$

Item	Number	Allocation	Unallocated
Substation infrastructure costs		12,000,000	12,000,000
Total Breakers	8		
TUOS Stand-alone breakers	2		
Share to TUOS	0.250	3,000,000	9,000,000
Common Service stand-alone breakers	3		
Share to Common Service	0.375	4,500,000	4,500,000
Exit service		4,500,000	

Example D

Substation Configuration

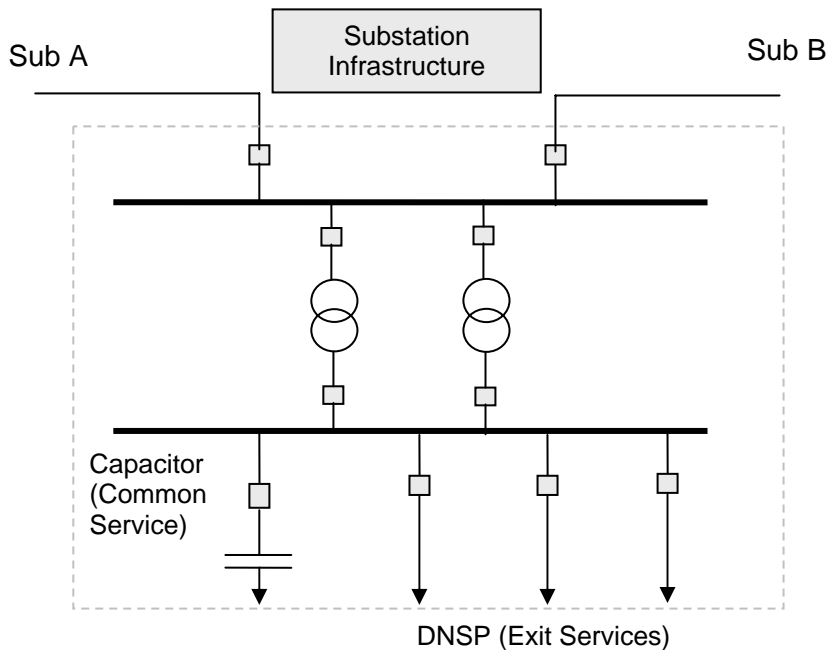

Step 1: The branches are Sub A, Sub B, DNSP1, DNSP2, DNSP3, Tie Transformer 1, Tie Transformer 2 and PCS.

Step 2: The total number of circuit breakers directly connected to branches is 10.

Step 3.1: The stand-alone arrangement for the provision of *prescribed TUOS services* to an equivalent standard is shown below and consists of 2 circuit breakers.

Stand Alone Prescribed TUOS



Step 3.2: The stand-alone arrangement for the provision of *prescribed common transmission services* to an equivalent standard is shown below and consists of 3 circuit breakers.

Stand Alone Prescribed Common Service

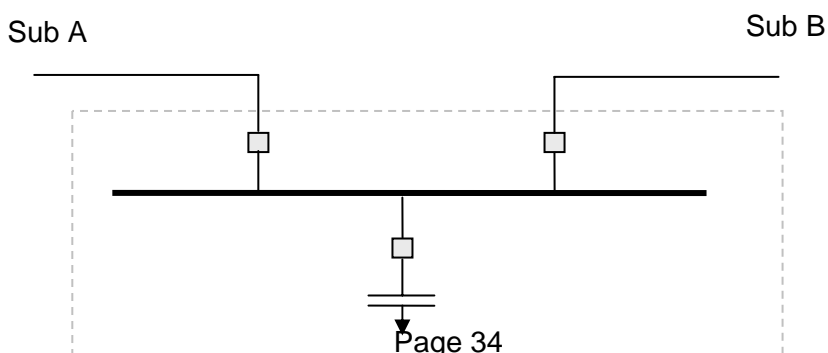



Step 4:

Assume total Infrastructure cost is \$15m.

Costs are allocated to prescribed TUOS in the ratio of the circuit breakers in the stand-alone arrangement to the total circuit breakers.

Infrastructure Cost Allocated to TUOS = $(2/10) \times \$15m = \$3m$

Unallocated = $\$15m - \$3m = \$12m$

Costs are allocated to *prescribed common service* in the ratio of the circuit breakers in the stand-alone arrangement to the total circuit breakers.

Infrastructure Cost allocated to Common Service = $(3/10) \times \$15m = \$4.5m$

Unallocated = $\$12m - \$4.5m = \$7.5m$

Remainder of Unallocated (calculated above) to be allocated to *prescribed entry and prescribed exit services*.

Infrastructure Cost allocated to Exit = $\$7.5m$

Item	Number	Allocation	Unallocated
Substation infrastructure costs		15,000,000	15,000,000
Total Breakers	10		
TUOS Stand-alone breakers	2		
Share to TUOS	0.200	3,000,000	12,000,000
Common Service stand-alone breakers	3		
Share to Common Service	0.300	4,500,000	7,500,000
Exit service		7,500,000	